

# PHILIPS

Data handbook



Electronic  
components  
and materials

## Electron tubes

Part 7b March 1977

Segment indicator tubes

Indicator tubes

Switching diodes

Dry reed contact units



# ELECTRON TUBES

Part 7b

March 1977

---

Segment indicator tubes

---

Indicator tubes

---

Switching diodes

---

Dry reed contact units

---

Associated accessories

---

Index

---

# RATING SYSTEM

(in accordance with IEC Publication 134)

## ABSOLUTE MAXIMUM RATING SYSTEM

Absolute maximum ratings are limiting values of operating and environmental conditions applicable to any electronic device of a specified type as defined by its published data, which should not be exceeded under the worst probable conditions.

These values are chosen by the device manufacturer to provide acceptable serviceability of the device, taking no responsibility for equipment variations, environmental variations, and the effects of changes in operating conditions due to variations in the characteristics of the device under consideration and of all other electronic devices in the equipment.

The equipment manufacturer should design so that, initially and throughout life, no absolute maximum value for the intended service is exceeded with any device under the worst probable operating conditions with respect to supply variation, equipment component variation, equipment control adjustment, load variations, signal variation, environmental conditions, and variations in characteristics of the device under consideration and of all other electronic devices in the equipment.

---

Some devices are labelled "MAINTENANCE TYPE" or "OBSOLESCE TYPE"

- Maintenance type - Available for equipment maintenance.  
No longer recommended for equipment production.
- Obsolescent type - Available until present stocks are exhausted.

# DATA HANDBOOK SYSTEM

Our Data Handbook System is a comprehensive source of information on electronic components, subassemblies and materials; it is made up of three series of handbooks each comprising several parts.

**ELECTRON TUBES**

**BLUE**

**SEMICONDUCTORS AND INTEGRATED CIRCUITS**

**RED**

**COMPONENTS AND MATERIALS**

**GREEN**

The several parts contain all pertinent data available at the time of publication, and each is revised and reissued periodically.

Where ratings or specifications differ from those published in the preceding edition they are pointed out by arrows. Where application information is given it is advisory and does not form part of the product specification.

If you need confirmation that the published data about any of our products are the latest available, please contact our representative. He is at your service and will be glad to answer your inquiries.

---

This information is furnished for guidance, and with no guarantee as to its accuracy or completeness; its publication conveys no licence under any patent or other right, nor does the publisher assume liability for any consequence of its use; specifications and availability of goods mentioned in it are subject to change without notice; it is not to be reproduced in any way, in whole or in part without the written consent of the publisher.

---

# ELECTRON TUBES (BLUE SERIES)

This series consists of the following parts, issued on the dates indicated.

Part 1a	Transmitting tubes for communication Tubes for r.f. heating      Types PE05/25 – TBW15/25	December 1975
Part 1b	Transmitting tubes for communication Tubes for r.f. heating Amplifier circuit assemblies	January 1976
Part 2	Microwave products Communication magnetrons Magnetrons for microwave heating Klystrons Travelling-wave tubes Isolators, Circulators	May 1976
Part 3	Special Quality tubes Miscellaneous devices	January 1975
Part 4	Receiving tubes	March 1975
Part 5a	Cathode-ray tubes	August 1976
Part 5b	Camera tubes Image intensifier tubes	May 1975
Part 6	Products for nuclear technology Channel electron multipliers Neutron tubes	January 1977
Part 7a	Gas-filled tubes Thyratrons Industrial rectifying tubes	March 1977
Part 7b	Gas-filled tubes Segment indicator tubes Indicator tubes	March 1977
Part 8	TV picture tubes	October 1975
Part 9	Photomultiplier tubes Phototubes (diodes)	June 1976

# SEMICONDUCTORS AND INTEGRATED CIRCUITS (RED SERIES)

This series consists of the following parts, issued on the dates indicated.

<b>Part 1a</b>	<b>Rectifier diodes, thyristors, triacs</b>	<b>March 1976</b>
	Rectifier diodes	Rectifier stacks
	Voltage regulator diodes (> 1,5 W)	Thyristors
	Transient suppressor diodes	Triacs
<b>Part 1b</b>	<b>Diodes</b>	<b>October 1975</b>
	Small signal germanium diodes	Voltage regulator diodes (< 1,5 W)
	Small signal silicon diodes	Voltage reference diodes
	Special diodes	Tuner diodes
<b>Part 2</b>	<b>Low-frequency transistors</b>	<b>December 1975</b>
<b>Part 3</b>	<b>High-frequency and switching transistors</b>	<b>April 1976</b>
<b>Part 4a</b>	<b>Special semiconductors</b>	<b>June 1976</b>
	Transmitting transistors	Dual transistors
	Microwave devices	Microminiature devices for thick- and thin-film circuits
	Field-effect transistors	
<b>Part 4b</b>	<b>Devices for optoelectronics</b>	<b>July 1976</b>
	Photosensitive diodes and transistors	Photocouplers
	Light emitting diodes	Infrared sensitive devices
	Displays	Photoconductive devices
<b>Part 5a</b>	<b>Professional analogue integrated circuits</b>	<b>November 1976</b>
	N.B. Consumer circuits will be issued in part 5b	
<b>Part 6</b>	<b>Digital integrated circuits</b>	<b>May 1976</b>
	LOC MOS HE family	
	GZ family	

# COMPONENTS AND MATERIALS (GREEN SERIES)

This series consists of the following parts, issued on the dates indicated.

<b>Part 1</b>	<b>Functional units, Input/output devices, Peripheral devices</b>		<b>November 1975</b>
	High noise immunity logic FZ/30-Series	Circuit blocks 90-Series	
	Circuit blocks 40-Series and CSA70	Input/output devices	
	Counter modules 50-Series	Hybrid integrated circuits	
	NORbits 60-Series, 61-Series	Peripheral devices	
<b>Part 2a</b>	<b>Resistors</b>		<b>February 1976</b>
	Fixed resistors	Negative temperature coefficient thermistors (NTC)	
	Variable resistors	Positive temperature coefficient thermistors (PTC)	
	Voltage dependent resistors (VDR)	Test switches	
	Light dependent resistors (LDR)		
<b>Part 2b</b>	<b>Capacitors</b>		<b>April 1976</b>
	Electrolytic and solid capacitors	Ceramic capacitors	
	Paper capacitors and film capacitors	Variable capacitors	
<b>Part 3</b>	<b>Radio, Audio, Television</b>		<b>January 1977</b>
	FM tuners	Components for black and white television	
	Loudspeakers	Components for colour television	
	Television tuners and aerial input assemblies		
<b>Part 4a</b>	<b>Soft ferrites</b>		<b>October 1976</b>
	Ferrites for radio, audio and television	Ferroxcube potcores and square cores	
	Beads and chokes	Ferroxcube transformer cores	
<b>Part 4b</b>	<b>Piezoelectric ceramics, Permanent magnet materials</b>		<b>December 1976</b>
<b>Part 5</b>	<b>Ferrite core memory products</b>		<b>July 1975</b>
	Ferroxcube memory cores	Core memory systems	
	Matrix planes and stacks		
<b>Part 6</b>	<b>Electric motors and accessories</b>		<b>September 1975</b>
	Small synchronous motors	Miniature direct current motors	
	Stepper motors		
<b>Part 7</b>	<b>Circuit blocks</b>		<b>September 1971</b>
	Circuit blocks 100 kHz-Series	Circuit blocks for ferrite core memory drive	
	Circuit blocks 1-Series		
	Circuit blocks 10-Series		
<b>Part 8</b>	<b>Variable mains transformers</b>		<b>July 1975</b>
<b>Part 9</b>	<b>Piezoelectric quartz devices</b>		<b>March 1976</b>
<b>Part 10</b>	<b>Connectors</b>		<b>November 1975</b>



## Segment indicator tubes





**DUAL 7-SEGMENT INDICATOR TUBE**  
 suitable for direct drive with 30 V ICs

Long-life segmented dual cold-cathode gas-filled indicator tube in a flat envelope for in-line numeric display applications, such as in digital measuring equipment, clocks, cash registers, weighing machines etc. The tube is suitable for soldering into the circuit. Two or more tubes may be stacked horizontally.

QUICK REFERENCE DATA	
Character height	15 mm
Characters	formed by 7 segments
Number of decades	2
Decimal point	to the lower right of the characters
Decade pitch (also for stacked tubes)	17,78 mm (0,7 in)

**MECHANICAL DATA**

Mounting position : any

The tube is provided with dual in-line tinned dip-solder pins for insertion in a printed-wiring board. ( e = 2,54 mm ). It may also be plugged into a socket.

Soldering

The dip-solder pins may be soldered for 5 s in solder of max. 260 °C.

**CHARACTERISTICS**

Ignition voltage, first ignition, 25 lx	$V_{ign}$	<	165	V
Ignition delay, first ignition, $V_{ba} = 165$ V, 25 lx	$T_d$	<	2	s
Ignition voltage, subsequent ignitions within 10 ms	$V_{ign}$	<	150	V
Primed ignition voltage	$V_{ignpr}$	$\leq$	143	V <sup>1)</sup>
Maintaining voltage				see graph
Extinction voltage	$V_{ext}$	$\geq$	125	V
Luminous intensity per segment			10	mCd/mA

<sup>1)</sup> Primed ignition voltage is the minimum anode to cathode voltage to ensure that the selected numeral ( including decimal point ) is completed after ignition of one segment.

Data based on pre-production devices.

**LIMITING VALUES** (Absolute max. rating system)

	segments	dec. points
Cathode current, d. c.	max. 0,7	max. 0,25 mA
	min. 0,25	min. 0,1 mA
Cathode current, mean, $T_{av} = \text{max. } 25 \text{ ms}$	max. 0,5	max. 0,2 mA
Cathode current, peak $T_{imp} = 0,2 \text{ ms}$	max. 3	max. 1,1 mA
	min. 0,35	min. 0,1 mA
Voltage between any two segments and/or decimal points	max.	125 V
Voltage between screen and any other electrode (tube ignited)	max.	125 V
Ambient temperature	max.	100 °C 1)
	min.	-50 °C 2)

**RECOMMENDED OPERATING CONDITIONS**

If the tube is used within its limiting values and according to the conditions below, a high-quality display is obtained and interdigit discharges are prevented, even with the worst combination of parameters.

For many applications the worst parameter combination will not occur. In those cases the conditions recommended below may be changed which may result in a cheaper drive circuit. These changes should, however, only be made after consulting the tube manufacturer.

**Static operation** see Fig. 1

Anode supply voltage	$V_{ba}$ max.	350	V
	min.	165	V

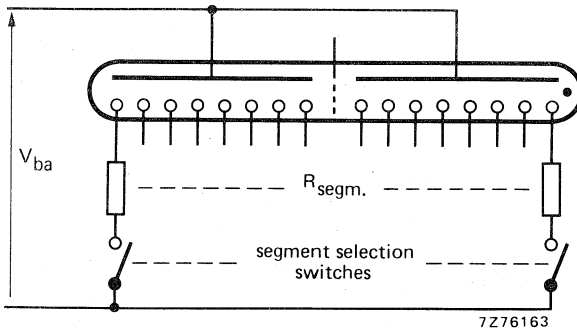

Fig. 1

Notes see page 3.

Dynamic operation see Fig.2

Anode supply	$V_{ba}$	max.	185	V
		min.	165	V
Screen supply voltage ( $R_{screen} = 1\text{ M}\Omega$ )	$V_{bs}$	max.	60	V
		min.	50	V
	$V_{aoff}$	max.	125	V
		min.	115	V

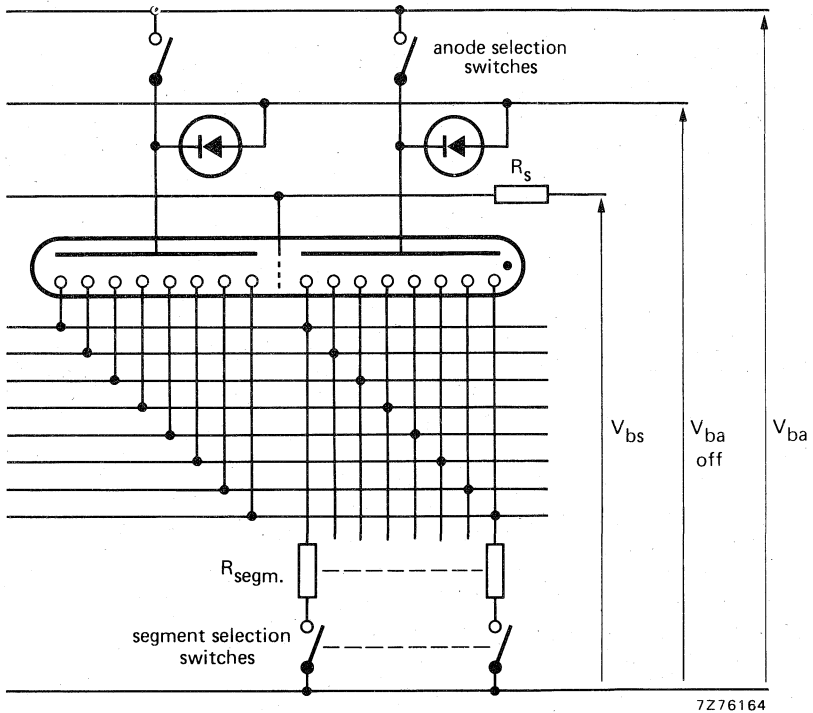

Fig. 2

1) Bulb temperatures above 70 °C result in changes in colour.

2) Bulb temperatures below 10 °C result in a reduced life expectancy and changes in characteristics.

DIMENSIONS AND CONNECTIONS

Dimensions in mm

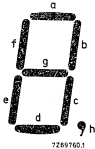
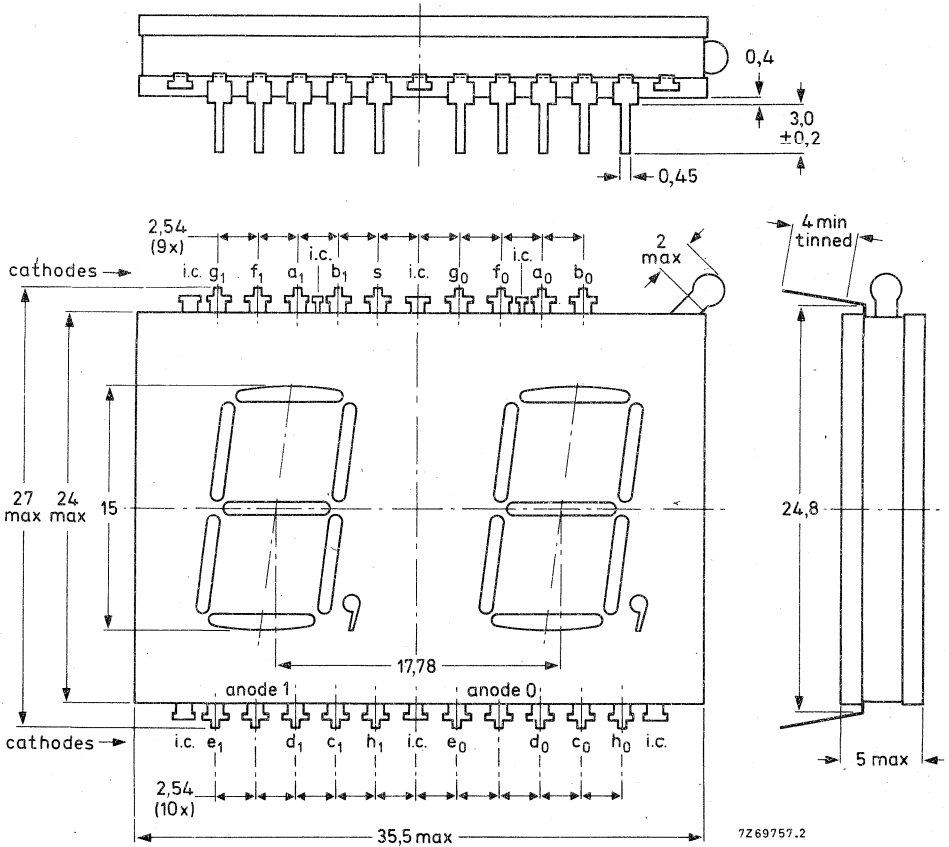

Segment designation

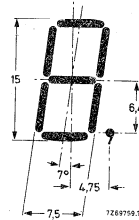

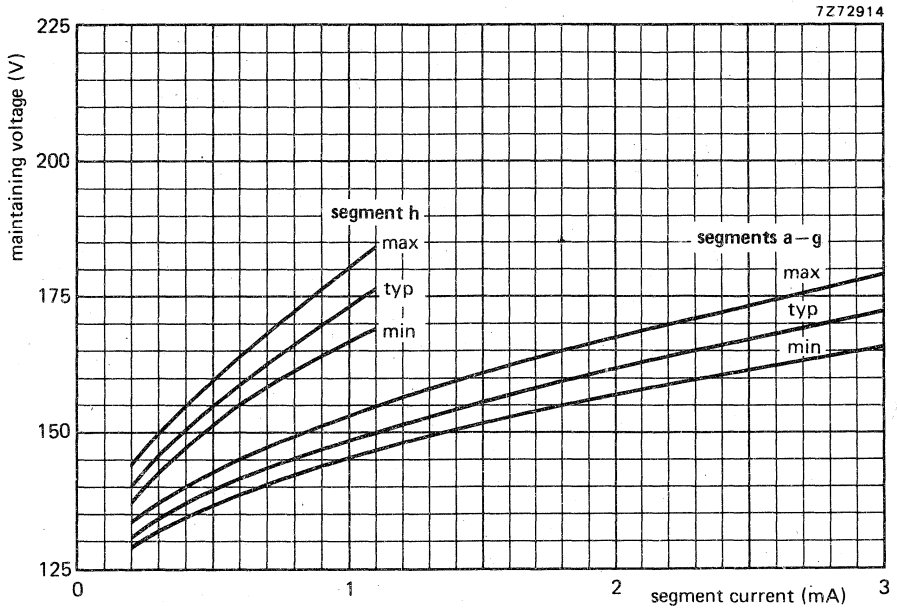

Maintaining voltage as a function of segment current.

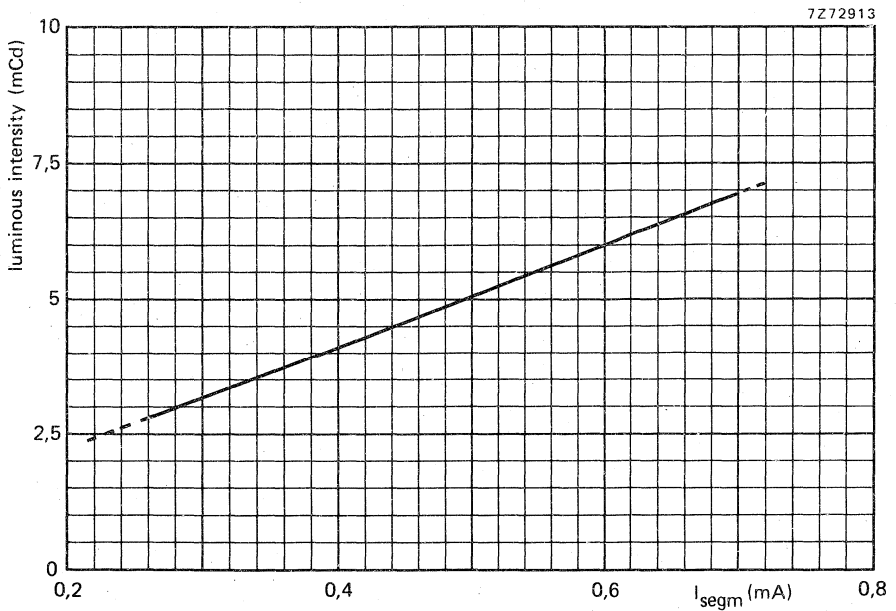

Luminous sensitivity as a function of d. c. segment current.

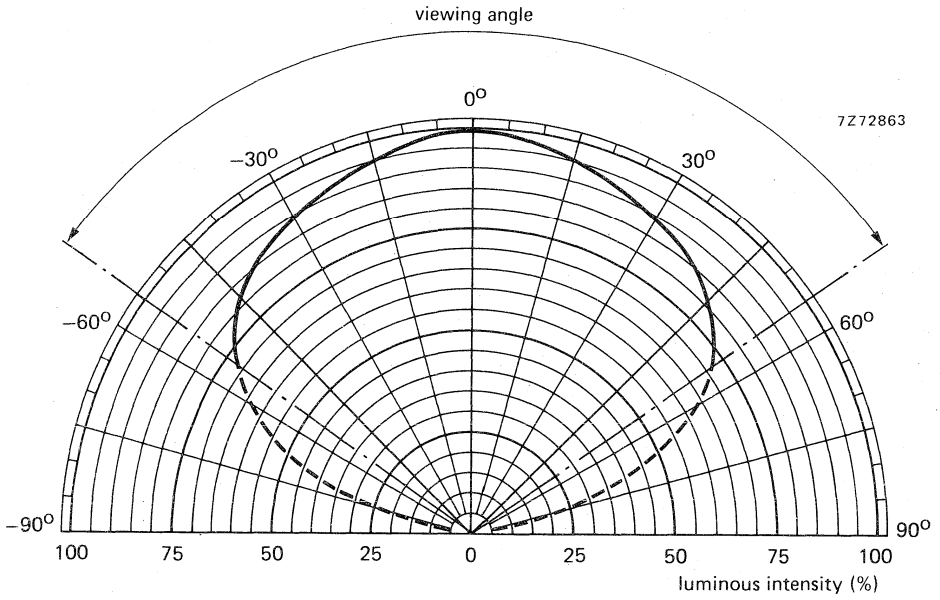

Relative luminous intensity as a function of the direction of viewing.



## 7-SEGMENT 1,5 DIGIT INDICATOR TUBE

Long-life segmented cold-cathode gas-filled indicator tube in a flat envelope for in-line display applications, such as in digital measuring equipment.  
The tube can be stacked with the ZM1550.

QUICK REFERENCE DATA		
Character height		15 mm
Characters	left compartment	+ - 1
	right compartment	formed by 7 segments
Numbers of decades		1, 5
Decimal point		to the lower right of the character
Decade pitch (also for stacked tubes)		17,78 mm (0,7 in)

Further information on request:



Indicator tubes





---

---

# COLD CATHODE INDICATOR TUBES

## TERMS AND DEFINITIONS

1. Indicator tube.

An indicator tube is a glow discharge tube designed to give a visual indication of the presence of an electrical signal.

A numerical indicator tube is one in which the indication is given in the form of numerals.

In a point indicator tube the indication is given by the position of the glow.

2. Ignition.

2.1 Ignition voltage (symbol  $V_{ign}$ )

The ignition voltage is the lowest direct potential, which when applied to a particular anode-cathode gap in the presence of some primary ionisation, will cause a self sustaining discharge to start in that anode-cathode gap.

2.2 Ignition delay.

The ignition delay is the time interval between the application of a direct potential (equal to or exceeding the ignition voltage) to a particular anode-cathode gap and the establishment of a self sustaining discharge in that gap.

The figure quoted applies to a tube which has been inoperative for a time long in comparison with the deionisation time.

3. Maintaining voltage (symbol  $V_m$ )

The maintaining voltage is the voltage between an anode and that cathode carrying the main discharge.

4. Extinguishing voltage (symbol  $V_{ext}$ )

The extinguishing voltage is the voltage between anode and cathode below which the glow discharge extinguishes and is equal to the lowest possible value of the maintaining voltage.

5. "On" cathode.

The "on" cathode is the cathode (numeral) which is required to be displayed and thus carries the main discharge.

6. "Off" cathode.

The "off" cathodes are the cathodes which are not required for display and thus act as probes in the main discharge.

7Z2 5232

- 
- 
7. Cathode selecting voltage (symbol  $V_{kk}$ )  
The cathode selecting voltage is the cathode voltage difference which is used for discrimination between the "off" cathodes and the "on" cathode.
  8. Anode selecting voltage (symbol  $V_{aa}$ )  
The anode selecting voltage is the anode voltage difference which is used to select the "on" cathode out of a group of cathodes.
  9. Anode to cathode bias voltage (bias voltage) (symbol  $V_{bias}$ )  
The anode to cathode bias voltage is the anode to cathode voltage before any cathode has been ignited. This voltage serves to reduce the required selecting voltage.
  10. Shield voltage (symbol  $V_s$ )  
The shield voltage is the voltage difference between the shield electrode and the "on" cathode and is used to prevent the penetration of the discharge from one compartment into another which is separated from the former by said shield.
  11. Cathode current (symbol  $I_k$ )  
The cathode current is the current flowing to the "on" cathode.
    - 11.1 Minimum cathode current for coverage (symbol  $I_{kmin.}$ )  
The minimum cathode current is the current necessary to ensure full coverage of the "on" cathode by the glow.
    - 11.2 Maximum cathode current (symbol  $I_{kmax.}$ )  
The maximum cathode current is the current at which the glow is still restricted to the "on" cathode.  
If this current is exceeded the glow may spread to connecting leads or other elements.
  12. Probe current (symbol  $I_{kk}$ )  
A probe current is the current flowing to or from an electrode which does not form part of the main discharge gap.  
(The magnitude and direction of this current will be dependent on the position of this electrode with respect to the main discharge and on the external circuit conditions).
  13. Anode current (symbol  $I_a$ )  
The anode current is the algebraic sum of cathode current and all probe currents.
  14. Life expectancy.  
End of life is reached when the characteristics of any one numeral surpass the stated limits.

7Z2 5233

---

---

## SHOCK AND VIBRATION

An indication for the ruggedness of the tube is the fact that 95% of the items sampled from normal production pass the shock and vibration tests specified below without perceptible damage.

These tests are carried out on non operating tubes.

Shock: 25  $g_{\text{peak}}$ , 1000 shocks in one of the three positions of the tube.

Vibration: 2.5  $g_{\text{peak}}$ , 50 Hz, during 32 hours in each of the three positions of the tube.







## INDICATOR TUBE

Long-life cold-cathode ten-digit indicator tube for side viewing.

QUICK REFERENCE DATA			
Numeral height		approx.	14 mm
Numerals		0 1 2 3 4 5 6 7 8 9	
Decimal point		to the left of the numerals	
Supply voltage	$V_{ba}$	min.	170 V
Anode current, average	$I_a$		2,5 mA
		peak	$I_{ap}$ max. 12 mA

## GENERAL

The numerals are 14 mm high and appear on the same base line allowing in-line read out.

## PRINCIPLE OF OPERATION

The tube contains ten cathodes in the form of ten numerals and one in the form of a decimal point, a primer, and one common anode. By applying a suitable voltage between the anode and one of the cathodes the corresponding numeral or the decimal point will be covered by a red neon glow.

The primer allows ionization without delay in strobe type or blanking applications.

## DIMENSIONS AND CONNECTIONS

Dimensions in mm

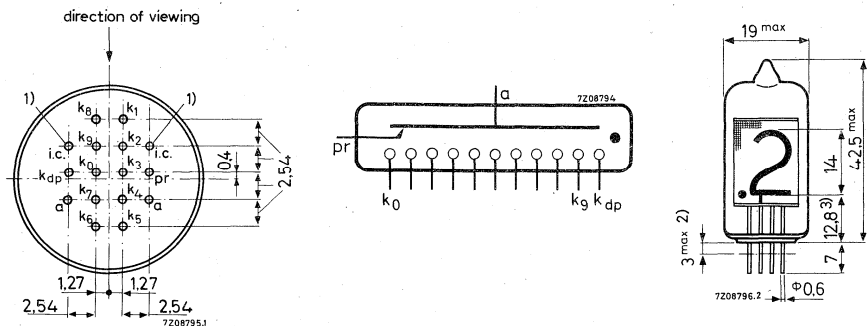

1) Length of i. c. pins max. 2,8 mm.

2) Not tinned.

3) Standard deviation 0,13 mm.

The deviations of the axis of the pins with respect to the true geometrical position cover an area of max. 0.3 mm diameter. The pin configuration is compatible with the reference grid for printed wiring according to IEC Publication 97 (0.1 in).

Mounting position: Any

Soldering

The pins may be dip-soldered at a solder temperature of max. 240 °C for maximum 10 seconds up to a point 5 mm from the seals.

Natural frequency

The natural frequencies of the numeral cathodes lie within the range from 300 Hz to 800 Hz.

**ACCESSORIES**

55701 Printed wiring mounting board (19 x 100 mm) on which the ZM1000 can be soldered; afterwards the combination can be mounted on a vertical printed wiring board carrying, e.g., the drive circuit. Can also be used with the snap-fit tube holder 55703.

55702 Tube socket (for 0.1 in grid). Phenolic. Tinned contacts.

55703 Snap-fit tube holder.

55704 Set of one left-hand and one right-hand end piece to complete the snap-fit indicator tube assembly.

**CHARACTERISTICS AND OPERATING CONDITIONS**

Ignition voltage	$V_{ign}$	max. 170 V
Maintaining voltage	$V_m$	see page 4
Anode current for coverage	$I_a$	min. 1.5 mA
(with or without decimal point and $V_{kk} = V_{kk_{min}} - V_{fl}$ , see page 5)	$I_a$	max. 4.5 mA
Cathode selecting voltage	$V_{kk}$	see page 5
Cathode resistor, decimal point	$R_{dp}$	100 $k\Omega \pm 10\%$ <sup>1)</sup>
Primer resistor	$R_{pr}$	10 $M\Omega \pm 10\%$
Extinction voltage	$V_{ext}$	min. 118 V

1) Lower values of this resistor are permitted. The anode current should be increased by the increase of decimal point current resulting from the decrease of this resistor.

Typical operation over full temperature range 0 °C to +70 °C.

D.C. operation see pages 4, 5, 6 and 7.

Pulse operation

Peak currents up to 12 mA can be allowed provided the average current value does not exceed 2.5 mA.

To avoid excessive glow on "off" cathodes, the cathode selecting voltage should exceed 65 V. Minimum pulse duration 100  $\mu$ s.

For further information consult the manufacturer.

**LIFE EXPECTANCY** at  $I_a = 2.5$  mA

This tube is manufactured on the same physical principles as other tubes in this category and it is expected that the life will be comparable, viz:

sequentially changing the display from one digit

to the others every 1000 h or less 100 000 h

Mean time between failures min. 200 000 h

**LIMITING VALUES** (Absolute max. rating system)

Anode voltage necessary for ignition  $V_a$  min. 170 V

Anode current,

average during any conduction period  $I_a$  min. 1.5 mA

average ( $T_{AV} = 20$  ms)  $I_a$  max. 4.5 mA

peak  $I_{a_p}$  max. 12 mA

Cathode selecting voltage  $V_{kk}$  see page 5

Bias voltage between anode and "off" cathodes  $V_{bias}$  max.  $V_{floating}$

Ambient temperature  $t_{amb}$  min. -50 °C <sup>1)</sup>

$t_{amb}$  max. +70 °C

**SHOCK AND VIBRATION**

An indication for the ruggedness of the tube is the fact that 95% of the items sampled from the normal production line pass the shock and vibration tests specified below without perceptible damage.

Shock: 25  $g_{peak}$ , 1000 shocks in one of the three positions of the tube.

Vibration: 2.5  $g_{peak}$ , 50 Hz, during 32 hours in each of the three positions of the tube.

<sup>1)</sup> Bulb temperatures below 10 °C result in a reduced life expectancy and changes in characteristics (see page 4).

For equipment to be used over a wide temperature range, "constant current operation" (high supply voltage with a high anode series resistor) is recommended.

7208791

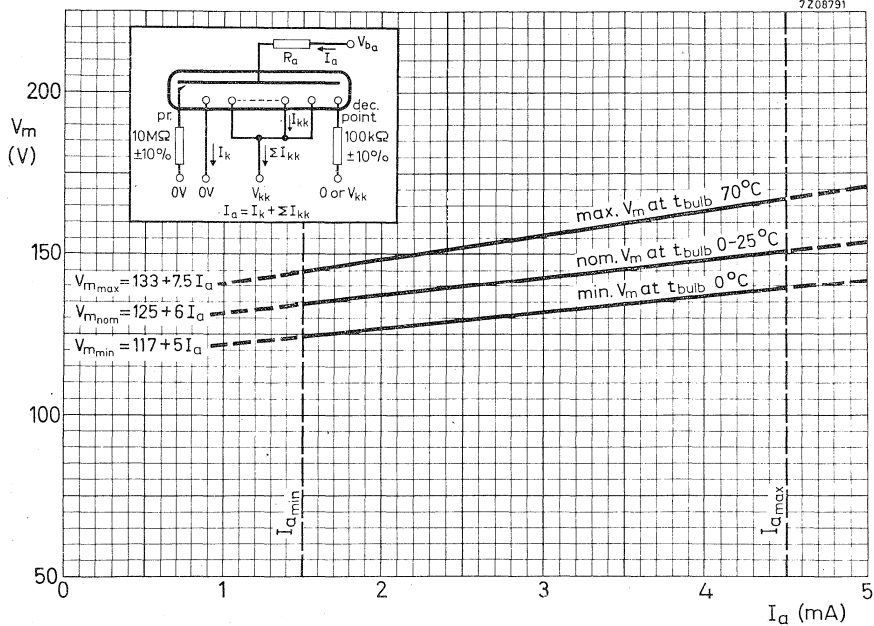

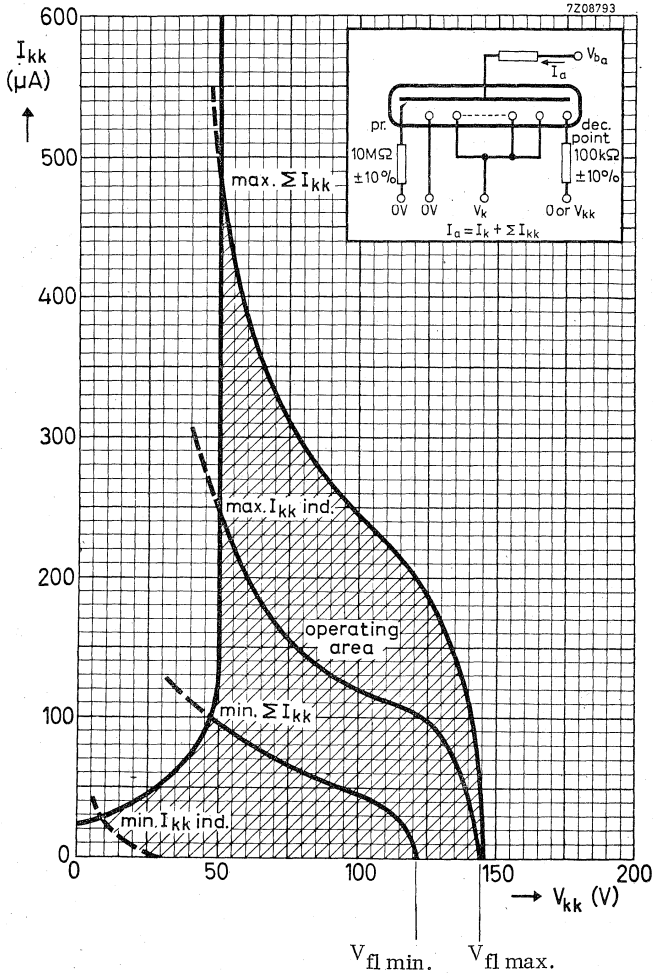

$I_{kk}$  individual and  $\Sigma I_{kk}$  versus cathode selecting voltage  $V_{kk}$  at  $I_a = 2.5$  mA.  
 $I_{kk}$  and  $\Sigma I_{kk}$  are proportional to the anode current within the operating range of  $I_a$  and with  $V_{kk} = 0$  V to 100 V.

The curves are valid for instantaneous values and for average values of anode current.

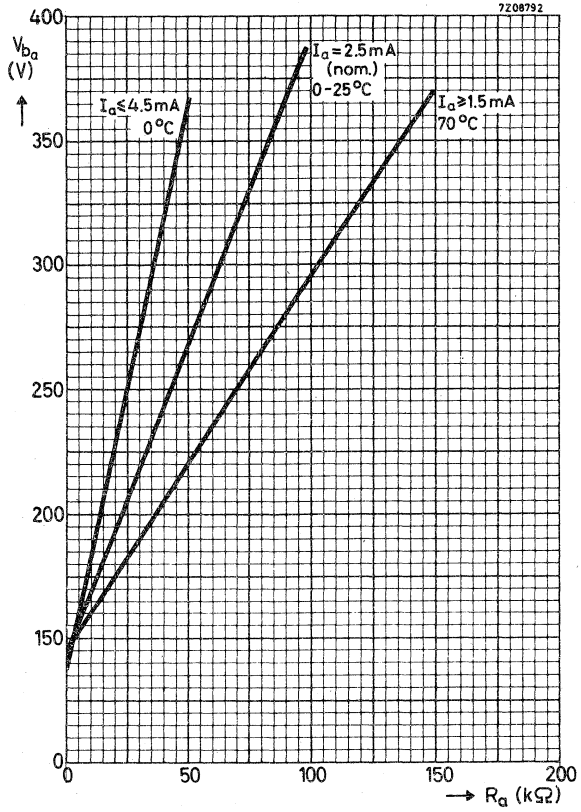

Graph denoting the relationships of D.C. anode supply voltage and required anode resistor to remain within the recommended operating region.

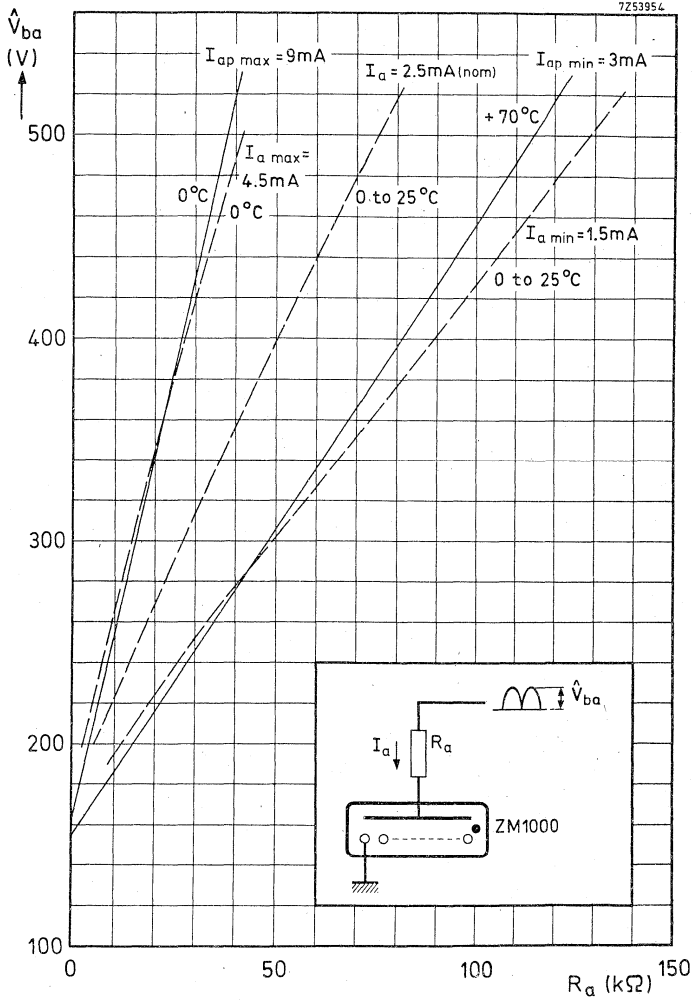





## INDICATOR TUBE

Long-life cold-cathode character indicator tube for side viewing.

QUICK REFERENCE DATA			
Character height		approx.	10 to 14 mm
Characters	+, -, ~, X, Y, Z		
Supply voltage	$V_{ba}$	min.	170 V
Anode current	$I_a$		2,5 mA

## GENERAL

Character indicator tube to be used in conjunction with ZM1000 numerical indicator tube for in-line read-out in e.g. digital instruments or numerical control applications.

## DIMENSIONS AND CONNECTIONS

Dimensions in mm

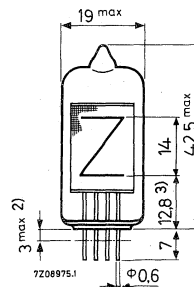
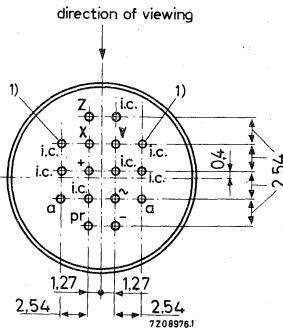

Mounting and Accessories: see ZM1000

## CHARACTERISTICS, OPERATING CONDITIONS AND LIMITING VALUES

These are essential the same as of type ZM1000.

- 1) Length of these i. c. pins max. 2,8 mm.
- 2) Not tinned.
- 3) Standard deviation 0,13 mm.



## INDICATOR TUBE

Long-life cold-cathode character indicator tube for side viewing.

QUICK REFERENCE DATA			
Character height		approx.	9 to 13 mm
Characters		ns, $\mu$ s, ms, s, Hz, kHz, MHz	
Supply voltage	$V_{ba}$	min.	170 V
Anode current	$I_a$		4 mA

## GENERAL

Character indicator tube to be used in conjunction with ZM1000 numerical indicator tube for in-line read-out in e. g. digital instruments such as frequency and time interval measuring apparatus.

## DIMENSIONS AND CONNECTIONS

Dimensions in mm

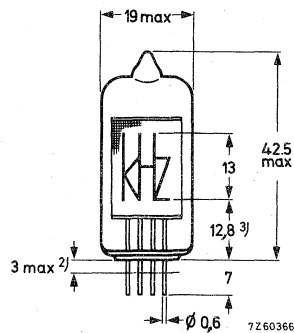
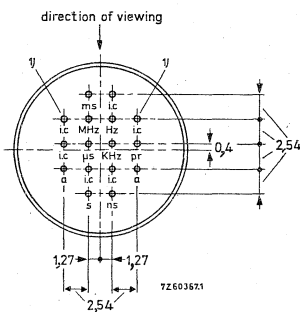

Mounting and Accessories: see ZM1000

1) Length of these i. c. pins max. 2,8 mm.

2) Not tinned.

3) Standard deviation 0,13 mm.



## INDICATOR TUBE

Long-life cold-cathode character indicator tube for side-viewing.

QUICK REFERENCE DATA			
Character height	approx.	9 to 14	mm
Characters	⊕ 1 ~		
Supply voltage	$V_{ba}$ min.	170	V
Anode current	$I_a$	2,5	mA

## PRINCIPLE OF OPERATION

By applying a suitable voltage between the anode and one of the cathodes the corresponding character will be covered by a red neon glow.

## CHARACTERISTICS, OPERATING CONDITIONS AND LIMITING VALUES

These are essentially the same as of type ZM1010.

## DIMENSIONS AND CONNECTIONS

Dimensions in mm

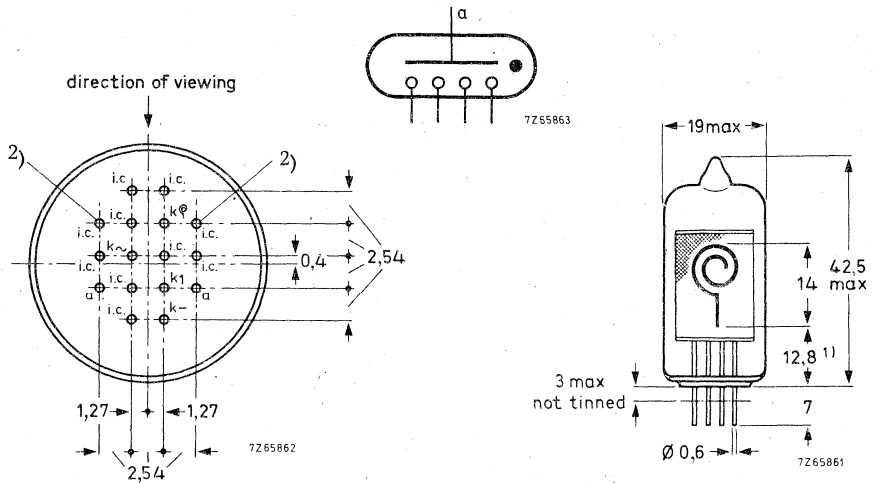

1) Standard deviation 0,13 mm.

2) Length of i. c. pins max. 2,8 mm.



## INDICATOR TUBE

Long-life cold-cathode ten-digit indicator tube for side viewing.  
The tube is designed for time-sharing (pulse) applications.

QUICK REFERENCE DATA			
Numeral height		approx.	14 mm
Numerals		0 1 2 3 4 5 6 7 8 9	
Decimal point		to the left of the numerals	
Supply voltage	$V_{ba}(\text{pulse})$	min.	170 V
Anode current, peak	$I_{ap}$	min.	6 mA
		max.	20 mA
		average	$I_a$ max. 2,5 mA

### GENERAL

The numerals are 14 mm high and appear on the same base line allowing in-line read-out.

### PRINCIPLE OF OPERATION

The tube contains ten cathodes in the form of ten numerals and one in the form of a decimal point; a primer, and one common anode. By applying a suitable voltage between the anode and one of the cathodes the corresponding numeral or the decimal point will be covered by a red neon glow.

The primer allows ionization without delay in strobe type or blanking applications.

### SHOCK AND VIBRATION

An indication for the ruggedness of the tube is the fact that 95% of the items sampled from the normal production line pass the shock and vibration tests specified below without perceptible damage.

Shock: 25  $g_{\text{peak}}$ , 1000 shocks on one of the three positions of the tube.

Vibration: 2,5  $g_{\text{peak}}$ , 50 Hz, during 32 hours in each of the three positions of the tube.

DIMENSIONS AND CONNECTIONS

Dimensions in mm

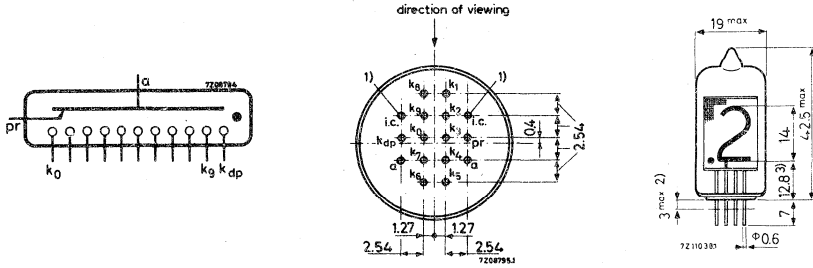

The deviation of the axes of the pins with respect to the true geometrical position cover an area of 0.3 mm diameter. The pin configuration is compatible with the reference grid for printed wiring according to IEC Publication 97 (0.1 in).

Mounting position: any

Soldering

The pins may be dip-soldered at a solder temperature of max. 240 °C for maximum 10 seconds up to a point 3 mm from the seals.

Natural frequency

The natural frequencies of the numeral cathodes lie within the range from 300 Hz to 800 Hz.

ACCESSORIES

55702 Tube socket (for 0.1 in grid). Phenolic. Tinned contacts.

55703 Snap-fit tube holder.

55704 Set of one left-hand and one right-hand end piece to complete the snap-fit indicator tube assembly.

- 1) i. c. pins max. length 2.8 mm
- 2) Not tinned
- 3) Standard deviation 0.13 mm



**CHARACTERISTICS AND OPERATING CONDITIONS**

Ignition voltage	$V_{ign}$	max. 170 V
Maintaining voltage	$V_m$	see page 4
Anode current, average ( $T_{av} = \text{max. } 20 \text{ ms}$ )	$I_a$	max. 2.5 mA
peak	$I_{ap}$	min. 6 mA
(with or without decimal point)	$I_{ap}$	max. 20 mA
Pulse duration	$T_{imp}$	min. 50 $\mu\text{s}$ <sup>1)</sup>
Cathode selecting voltage (see also page 4)	$V_{kk}$	min. 70 V <sup>2)</sup>
	$V_{kk}$	max. 115 V
Cathode resistor, decimal point	$R_{dp}$	10 $k\Omega \pm 10\%$ <sup>3)</sup>
Primer resistor (anode to primer supply voltage min. 170 V)	$R_{pr}$	10 $M\Omega \pm 10\%$
Extinguishing voltage	$V_{ext}$	min. 118 V

**LIFE EXPECTANCY** at  $I_a = 2 \text{ mA}$

The life expectancy is dependent on the instantaneous and average values of anode current:

sequentially changing the display from one digit to the others every 100 h or less, $I_{ap} = 10 \text{ mA}$	100 000 h
$I_{ap} = 20 \text{ mA}$	20 000 h
Mean time between failures	min. 200 000 h

**LIMITING VALUES** (Absolute max. rating system)

Anode voltage necessary for ignition, pulse	$V_{ap}$	min. 170 V
Anode current, average ( $T_{av} = 20 \text{ ms}$ )	$I_a$	max. 2.5 mA
peak	$I_{ap}$	min. 6 mA
	$I_{ap}$	max. 20 mA
Pulse duration	$T_{imp}$	min. 10 $\mu\text{s}$
Cathode selecting voltage	$V_{kk}$	min. 70 V
	$V_{kk}$	max. 115 V
"Off" anode voltage	$V_{a"off"}$	max. 115 V
Ambient temperature	$t_{amb}$	min. -50 $^{\circ}\text{C}$ <sup>4)</sup>
	$t_{amb}$	max. +70 $^{\circ}\text{C}$

1) Pulse durations down to 10  $\mu\text{s}$  are allowed provided the minimum peak anode current is not less than 10 mA.

2) Lower values of  $V_{kk}$  result in increasing background glow impairing readability.

3) The decimal point cathode may not be operated without extra current limiting resistor unless a numeral cathode is operated simultaneously.

4) Bulb temperatures below 10  $^{\circ}\text{C}$  result in a reduced life expectancy and changes in characteristics.

For equipment to be used over a wide temperature range, "constant current operation" is recommended.

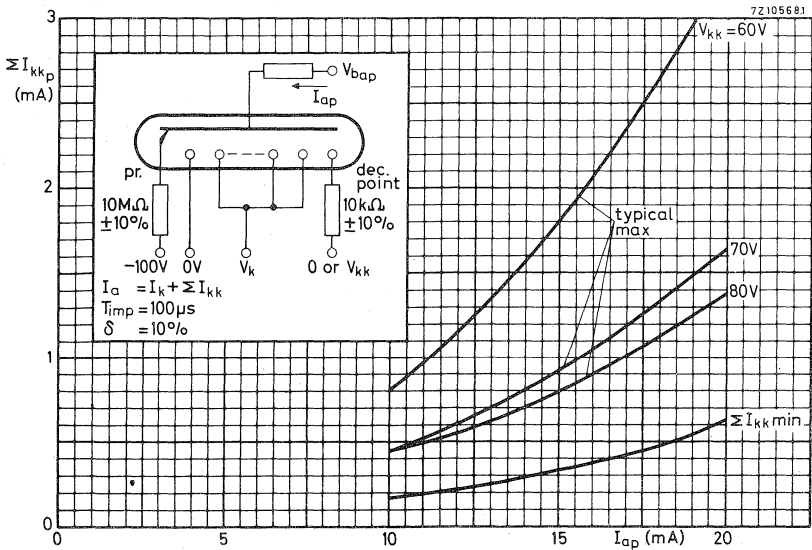
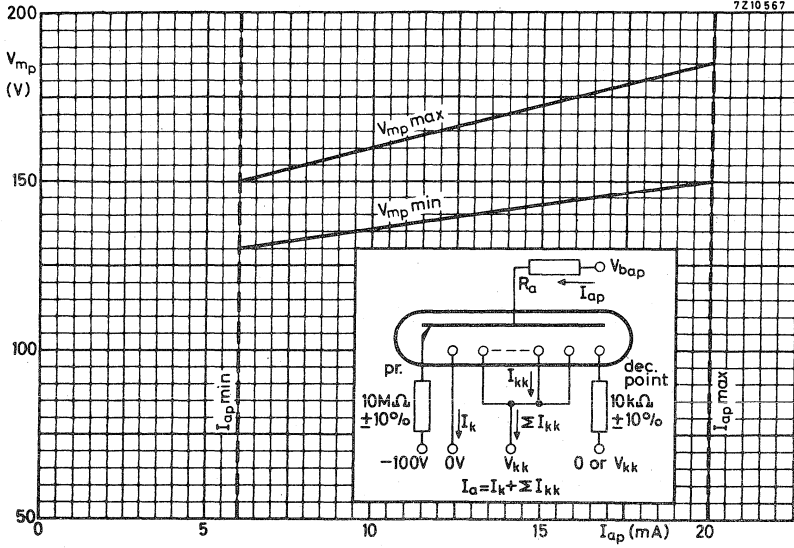

## INDICATOR TUBE

Long-life cold-cathode ten-digit indicator tube for side-viewing.

## QUICK REFERENCE DATA

Numeral height	approx.	14	mm
Numerals		0 1 2 3 4 5 6 7 8 9	
Decimal point		to the left of the numerals	
Supply voltage	$V_{ba}$	min.	170 V
Anode current	$I_a$		2,5 mA

## GENERAL

The numerals are 14 mm high and appear on the same base line allowing in-line read out.

## PRINCIPLE OF OPERATION

By applying a suitable voltage between the anode and one of the cathodes the corresponding numeral or the decimal point will be covered by a red neon glow.

## DIMENSIONS AND CONNECTIONS

Dimensions in mm

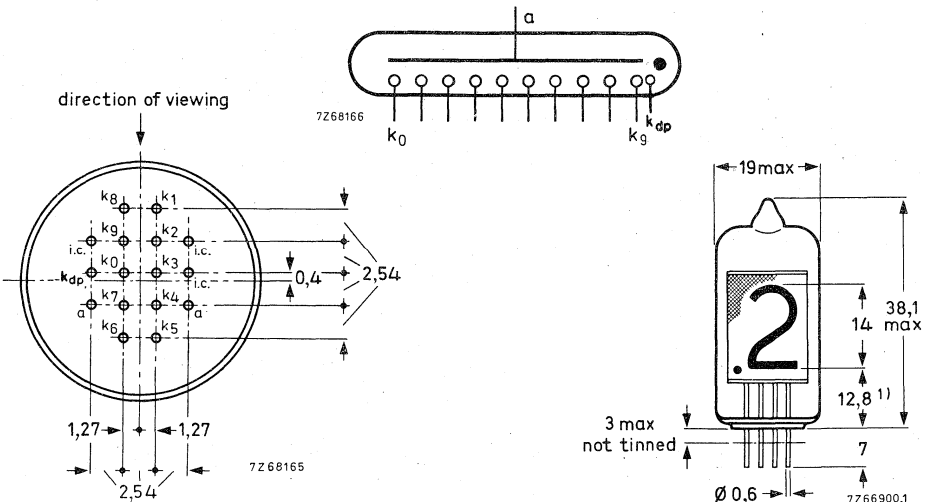

1) Standard deviation 0,13 mm.

The deviations of the axis of the pins with respect to the true geometrical position cover an area of max. 0,3 mm diameter. The pin configuration is compatible with the reference grid for printed wiring according to IEC Publication 97 (0,1 in).

Mounting position: Any

Soldering:

The pins may be dip-soldered at a solder temperature of max. 240 °C for maximum 10 s up to a point 5 mm from the seals.

**ACCESSORIES**

- 55701 Printed wiring mounting board (19 x 100 mm) on which the tube can be soldered; afterwards the combination can be mounted on a vertical printed wiring board carrying, e.g., the drive circuit.
- 55702 Tube socket compatible with IEC reference grid for printed wiring (0,1 in). Phenolic. Tinned pins.

**CHARACTERISTICS AND OPERATING CONDITIONS**

Ignition voltage	$V_{ign}$	max.	170	V
Maintaining voltage	$V_m$	see page	4	
Anode current for coverage	$I_a$	max.	3,5	mA
		min.	1,5	mA
Cathode selecting voltage	$V_{kk}$	see page	4	
Extinction voltage	$V_{ext}$	min.	118	V

**LIFE EXPECTANCY** at  $I_a = 2,5$  mA

The tube is manufactured on the same physical principles as other tubes in this category and it is expected that the life will be comparable, viz:

Sequentially changing the display from one digit to the others every 1000 h or less		100 000	h
Mean time between failures	min.	200 000	h

**LIMITING VALUES** (Absolute max. rating system)

Anode voltage necessary for ignition	$V_a$	min.	170	V
Anode current	$I_a$	max.	3,5	mA
		min.	1,5	mA
Cathode selecting voltage	$V_{kk}$	max.	100	V
		min.	60	V
Ambient temperature	$t_{amb}$	max.	+70	°C
		min.	-50	°C

Bulb temperatures below 10 °C result in a reduced life expectancy and changes in characteristics.

**SHOCK AND VIBRATION**

An indication for the ruggedness of the tube is the fact that 95% of the items sampled from the normal production line pass the shock and vibration test specified below without perceptible damage.

Shock 25  $g_{\text{peak}}$ , 1000 shocks in one of the three positions of the tube.

Vibration 2,5  $g_{\text{peak}}$ , 50 Hz, during 32 hours in each of the three positions of the tube.



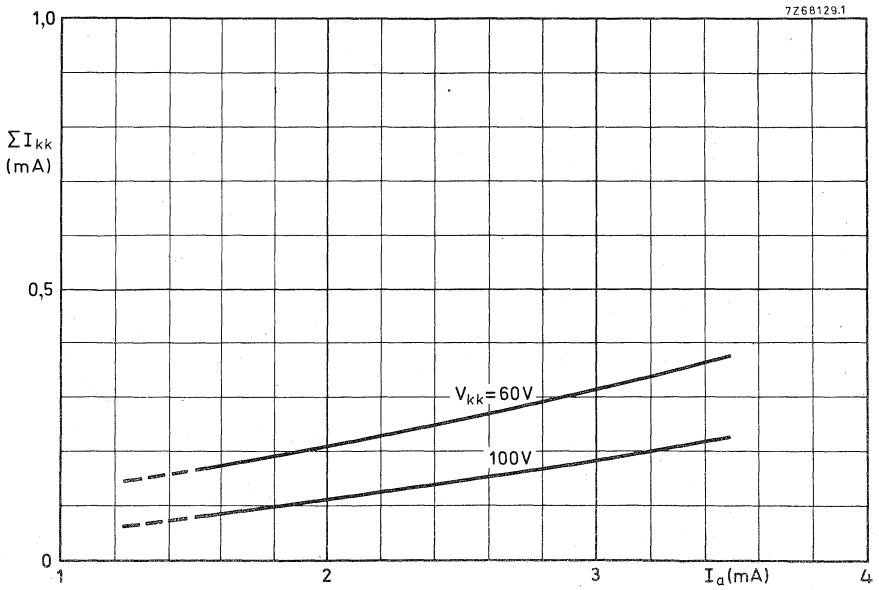
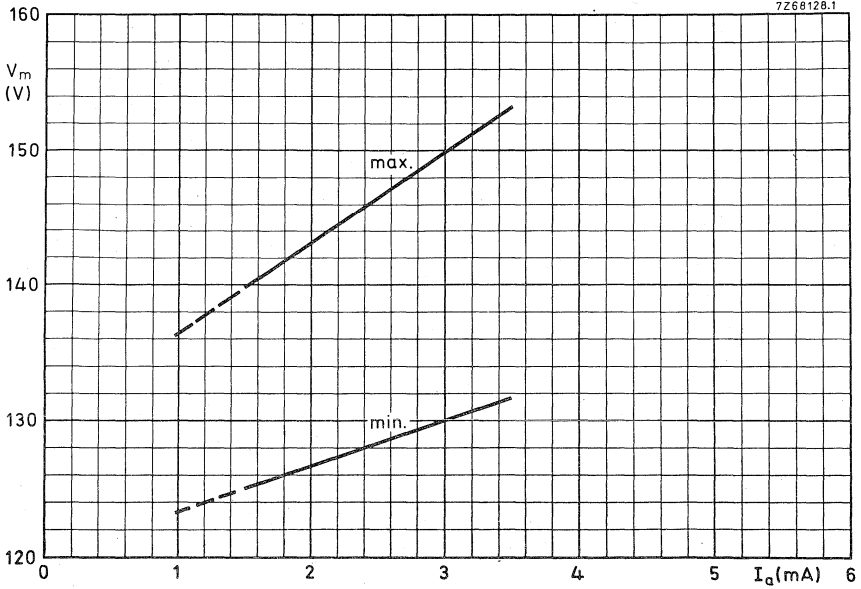

## INDICATOR TUBE

Long-life cold-cathode nine-digit indicator tube for side-viewing.

QUICK REFERENCE DATA			
Numeral height	approx.	14	mm
Numerals		0 1 2 3 4 5 6 7 8	
Supply voltage	$V_{ba}$	min.	170 V
Anode current	$I_a$		2,5 mA

## GENERAL

The numerals are 14 mm high and appear on the same base line allowing in-line read out.

## PRINCIPLE OF OPERATION

By applying a suitable voltage between the anode and one of the cathodes the corresponding numeral will be covered by a red neon glow.

## CHARACTERISTICS, OPERATING CONDITIONS AND LIMITING VALUES

These are essentially the same as of type ZM1010.

## DIMENSIONS AND CONNECTIONS

Dimensions in mm

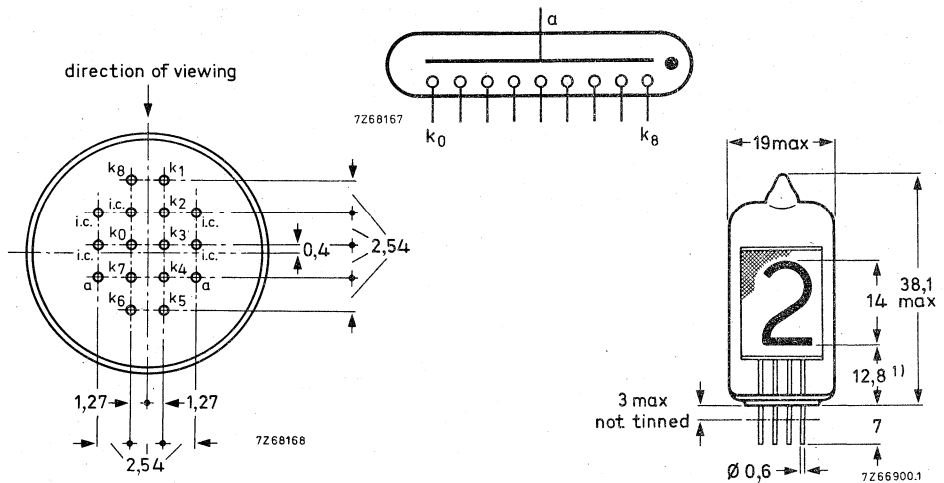

1) Standard deviation 0,13 mm.

## INDICATOR TUBE

Long life cold-cathode eight-digit indicator tube for side-viewing.

QUICK REFERENCE DATA			
Numeral height		approx.	14 mm
Numerals		1 2 3 4 5 6 7 8	
Supply voltage	$V_{ba}$	min.	170 V
Anode current	$I_a$		2,5 mA

### GENERAL

The numerals are 14 mm high and appear on the same base line allowing in-line read out.

### PRINCIPLE OF OPERATION

By applying a suitable voltage between the anode and one of the cathodes the corresponding numeral will be covered by a red neon glow.

### CHARACTERISTICS, OPERATING CONDITIONS AND LIMITING VALUES

These are essentially the same as of type ZM1010.

### DIMENSIONS AND CONNECTIONS

Dimensions in mm

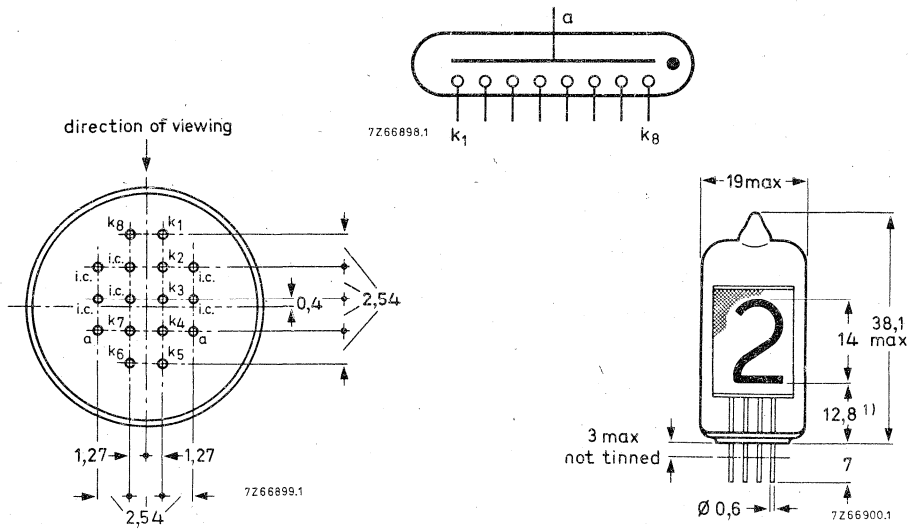

<sup>1)</sup> Standard deviation 0,13 mm



## INDICATOR TUBE

Long-life cold-cathode seven-digit indicator tube for side-viewing.

QUICK REFERENCE DATA			
Numeral height		approx.	14 mm
Numerals		0 1 2 3 4 5 6	
Supply voltage	$V_{ba}$	min.	170 V
Anode current	$I_a$		2,5 mA

## GENERAL

The numerals are 14 mm high and appear on the same base line allowing in-line read out.

## PRINCIPLE OF OPERATION

By applying a suitable voltage between the anode and one of the cathodes the corresponding numeral will be covered by a red neon glow.

## CHARACTERISTICS, OPERATING CONDITIONS AND LIMITING VALUES

These are essentially the same as of type ZM1010.

## DIMENSIONS AND CONNECTIONS

Dimensions in mm

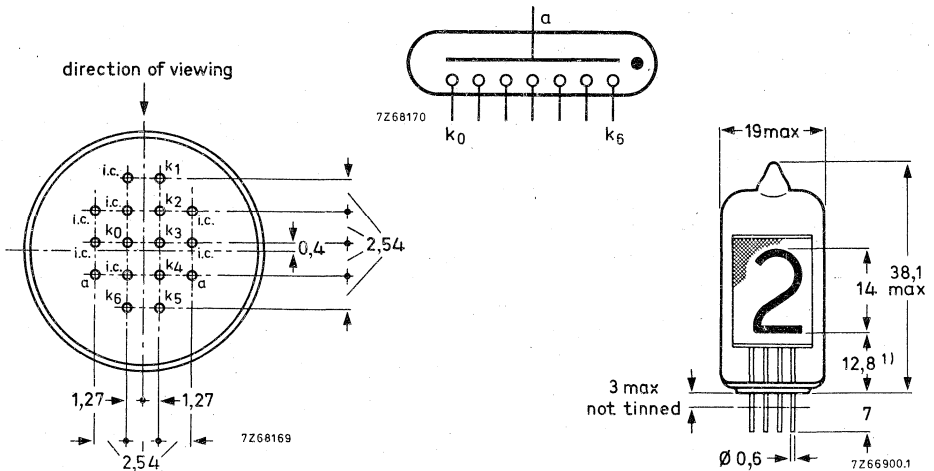

<sup>1)</sup> Standard deviation 0,13 mm.

## INDICATOR TUBE

Long life cold-cathode six-digit indicator tube for side-viewing

### QUICK REFERENCE DATA

Numeral height	approx.	14	mm
Numerals		1 2 3 4 5 6	
Supply voltage	$V_{ba}$ min.	170	V
Anode current	$I_a$	2,5	mA

### GENERAL

The numerals are 14 mm high and appear on the same base line allowing in-line read out.

### PRINCIPLE OF OPERATION

By applying a suitable voltage between the anode and one of the cathodes the corresponding numeral will be covered by a red neon glow.

### CHARACTERISTICS, OPERATING CONDITIONS AND LIMITING VALUES

These are essentially the same as of type ZM1010.

### DIMENSIONS AND CONNECTIONS

Dimensions in mm

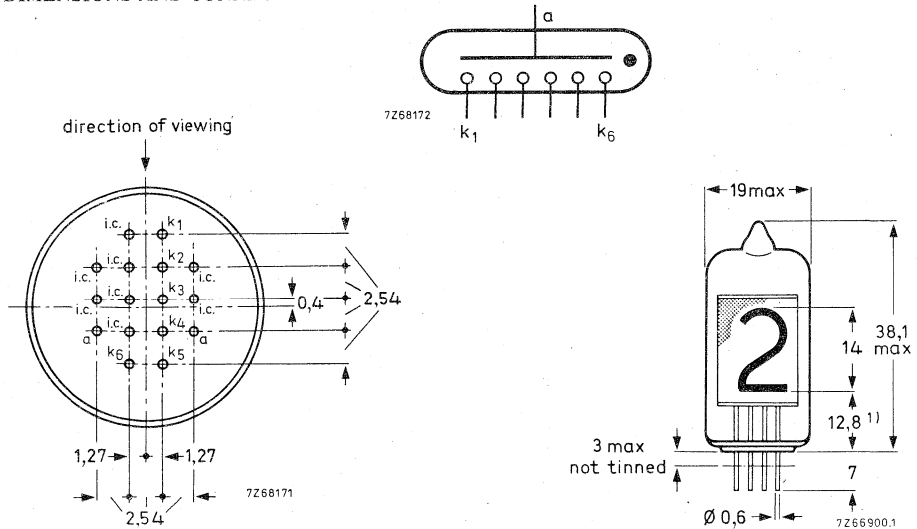

<sup>1)</sup> Standard deviation 0,13 mm

## INDICATOR TUBE

Long-life cold-cathode eight-digit indicator tube for side-viewing.

QUICK REFERENCE DATA			
Numeral height		approx.	14 mm
Numerals		1 2 3 4 5 6 7 8	
Supply voltage	$V_{ba}$	min.	170 V
Anode current	$I_a$		2,5 mA

### GENERAL

The numerals are 14 mm high and appear on the same base line allowing in-line read out.

### PRINCIPLE OF OPERATION

By applying a suitable voltage between the anode and one of the cathodes the corresponding numeral will be covered by a red neon glow.

### CHARACTERISTICS, OPERATING CONDITIONS AND LIMITING VALUES

These are essentially the same as of type ZM1010.

### DIMENSIONS AND CONNECTIONS

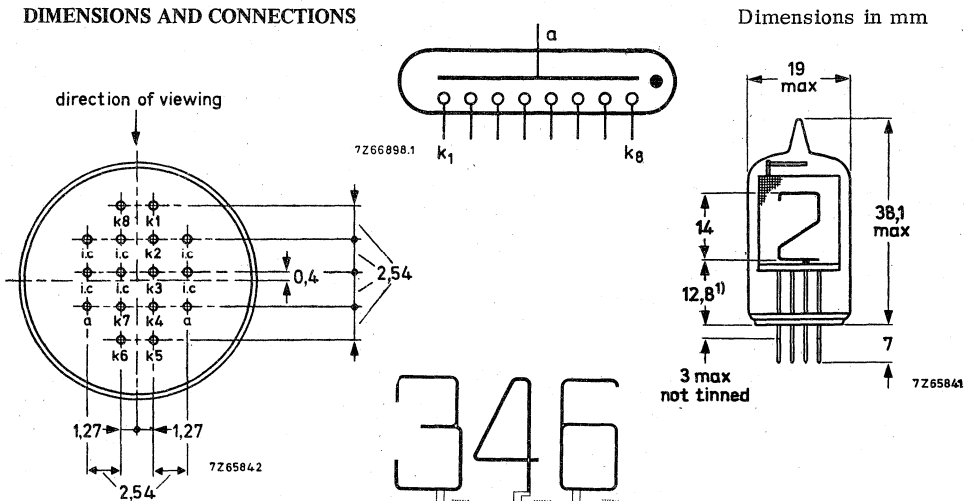

<sup>1)</sup> Standard deviation 0,13 mm.



## INDICATOR TUBE

Long life cold cathode ten digit numeral indicator tube for top viewing.

QUICK REFERENCE DATA			
Numeral height	15	mm	
Numerals	1 2 3 4 5 6 7 8 9 0		
Supply voltage	min. 170	V	
Anode current	2	mA	

### GENERAL

The numerals are 15 mm high and appear on the same base line allowing in-line read out. The ZM1020 is provided with a red contrast filter.

The ZM1020/01 is identical with the ZM1020 but has tinned pins.

### PRINCIPLE OF OPERATION

The tube contains ten cathodes in the form of ten figures and one common anode. By applying a suitable voltage between the anode and one of the ten cathodes the corresponding numeral will be covered by a red neon glow.

### DIMENSIONS AND CONNECTIONS

Dimensions in mm

Base: B13B

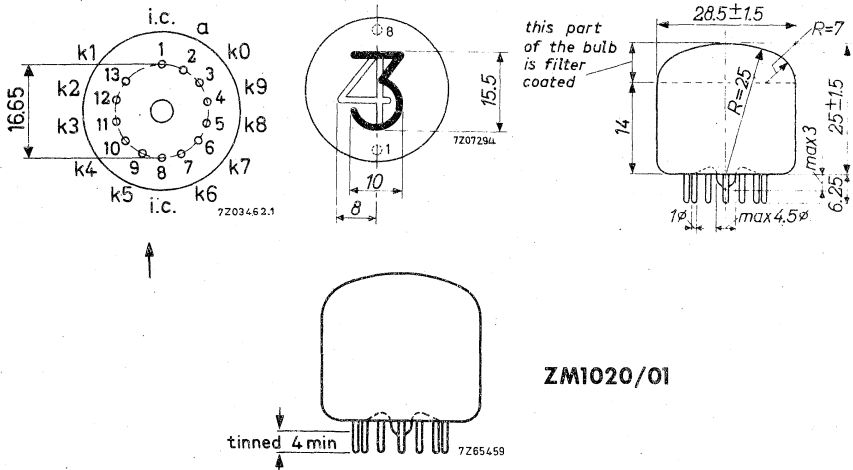

ZM1020/01

Mounting position: any

The numerals are viewed through the dome of the envelope. The numerals will appear upright (within 1.5°) when the tube is mounted with the line through pins 1 and 8 vertical, pin 8 being uppermost.

Accessories

Socket type 2422 505 00001  
or  
2422 505 00002

**CHARACTERISTICS AND OPERATING CONDITIONS**

(Valid over life and full temperature range)

Ignition voltage	$V_{ign}$	max. 170 V
Maintaining voltage	$V_m$	see sheet 4
Anode current for coverage, averaged during any conduction period	$I_a$	min. 1 mA
Anode current, average ( $T_{av} = \text{max. } 20 \text{ ms}$ )	$I_a$	max. 3 mA
peak	$I_{ap}$	max. 6 mA
Cathode selecting voltage	$V_{kk}$	see sheet 5
Extinguishing voltage	$V_{ext}$	min. 118 V

Typical operation 1)

D.C. operation

See sheets 5 and 6

A.C. operation

See sheets 5 and 7

1) Bulb temperatures below 10 °C result in a reduced life expectancy and changes in characteristics (see sheet 4).

In designing equipment to be used over a wide temperature range the use of "constant current operation" (high supply voltage with a high anode series resistor) is recommended.

**LIFE EXPECTANCY AND RELIABILITY** (at  $I_a = 2 \text{ mA}$ )

Sequentially changing the display from one digit to the others every 1000 h. or less 100.000 h

The reliability has been assessed in a life test programme totalling  $4.5 \times 10^6$  tube hours. The longest test period was 50.000 hrs on 47 tubes. No failures have been found. The Mean Time between Failures is better than  $10^6$  hrs which corresponds with a failure rate of less than 0.1 % per 1000 hrs at a confidence level of 95 %.

**LIMITING VALUES** (Absolute max. rating system)

Anode voltage necessary for ignition	$V_a$	min. 170 V
Anode current, D.C.	$I_a$	min. 1 mA
rectified A.C. and pulse	$I_{ap}$	min. 2 mA
average ( $T_{av} = \text{max. } 20 \text{ ms}$ )	$I_a$	max. 3 mA
peak	$I_{ap}$	max. 10 mA <sup>1)</sup>
Cathode selecting voltage	$V_{kk}$	see lines N and W on sheet 5
Bias voltage between anode and "off" cathodes (see sheet 5)	$V_{bias}$	max. $V_{floating}$
Ambient temperature	$t_{amb}$	min. -50 °C max. +70 °C

**SHOCK AND VIBRATION**

An indication for the ruggedness of the tube is the fact that 95% of the items sampled from the normal production line pass the shock and vibration tests specified below without perceptible damage.

Shock: 25  $g_{peak}$ , 1000 shocks in one of the three positions of the tube.

Vibration: 2.5  $g_{peak}$ , 50 Hz, during 32 hours in each of the three positions of the tube.

<sup>1)</sup> Above  $I_a = 6 \text{ mA}$  the connecting wires and eyelets may be covered by the glow.

7207256

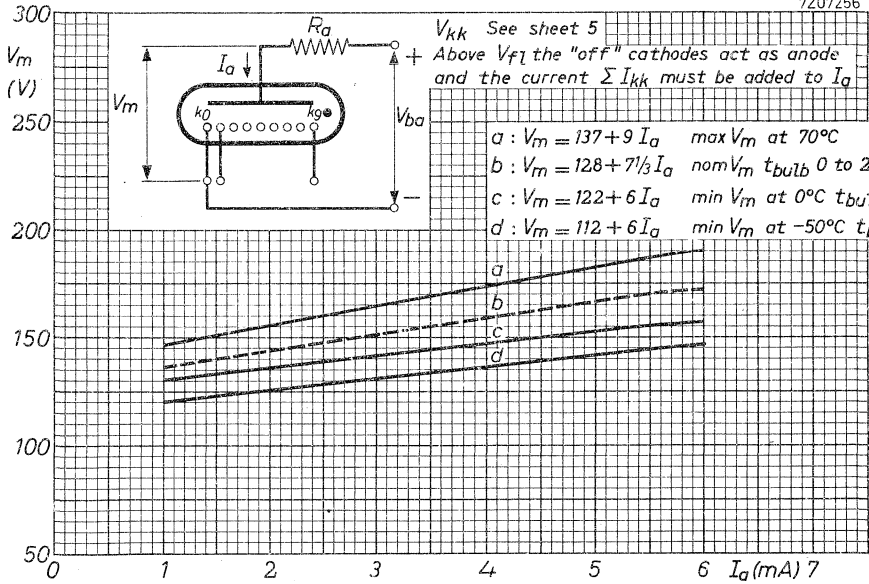



$I_{kk}$  individual and  $\Sigma I_{kk}$  versus cathode selecting voltage  $V_{kk}$  at  $I_a = 2 \text{ mA}$ .  
 $I_{kk}$  and  $\Sigma I_{kk}$  are proportional to anode current in the range  $V_{kk} = 0$  to  $100 \text{ V}$ .

The range of  $V_{fl}$  ( $I_{kk} = 0$ ) shifts to the right/left at increasing/decreasing anode current ( $8 \text{ V/mA}$ ).

The curves are valid for instantaneous and for average values of anode current.

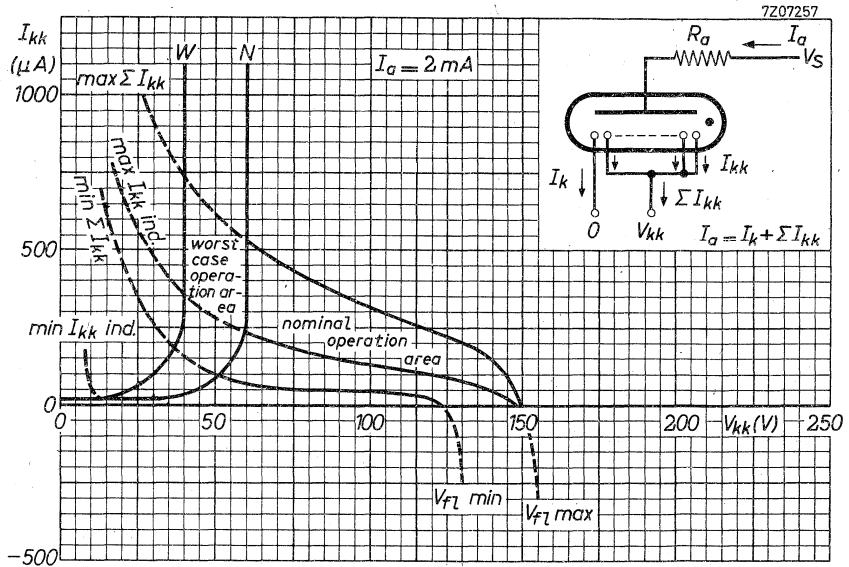

For low cathode selecting voltages the current  $I_{kk}$  to the "off" cathodes will increase and the readability of the "on" cathode will be affected. It is therefore recommended to use a nominal operating point to the right of line N.

Under the worst operating conditions the operating point should never reach the area left of line W.

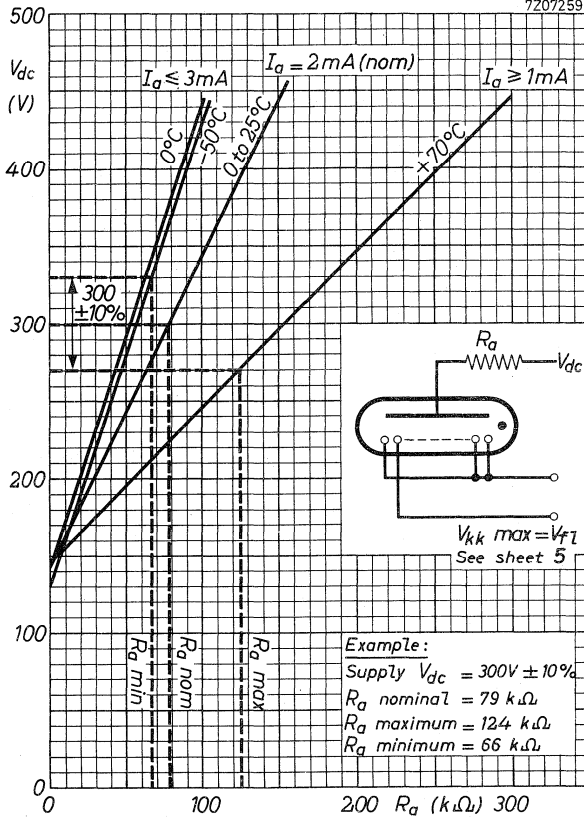

Graph denoting the relationship of D.C. anode supply voltage and required anode resistor to remain within the recommended operating region.

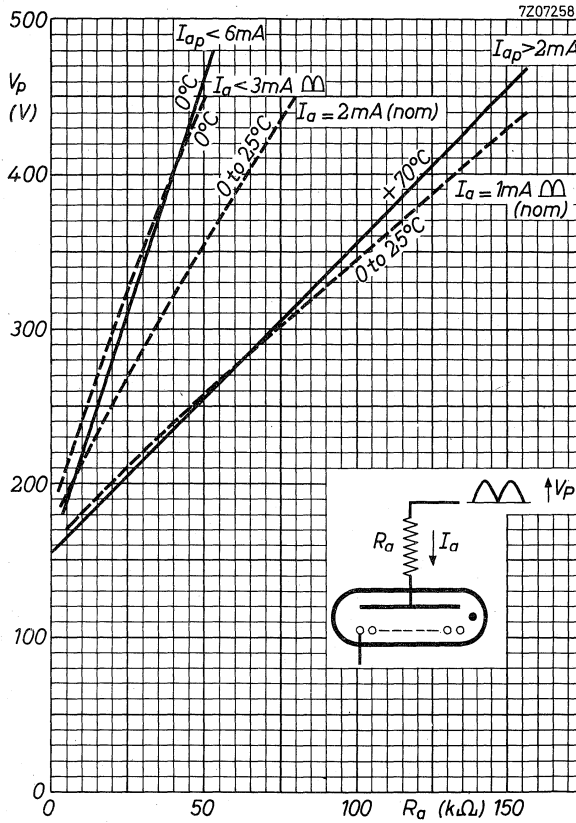

Graph denoting the relationship of the peak value of full-wave unsmoothed rectified A.C. anode supply voltage and the required anode resistor to remain within the recommended operating area.



## INDICATOR TUBE

Cold cathode character indicator tube for top viewing.

QUICK REFERENCE DATA	
Character height	15 mm
Characters	A, V, Ω, %, ., +, -, ~
Supply voltage	min. 170 V
Anode current	2 mA

### DIMENSIONS AND CONNECTIONS

Dimensions in mm

Base: B13B

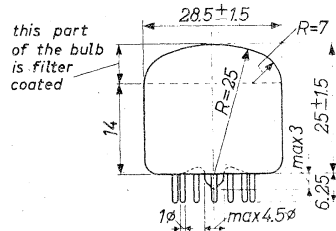
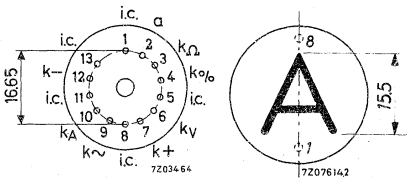

### CHARACTERISTICS, OPERATING CONDITIONS AND LIMITING VALUES

These are essentially the same as those of type ZM1020.



## INDICATOR TUBE

The type ZM1022 is electrically identical with type ZM1020 but has no filter coating.  
 The use of a separate amber filter (i.e. blue absorbing) is recommended.

### DIMENSIONS AND CONNECTIONS

Dimensions in mm

Base: B13B

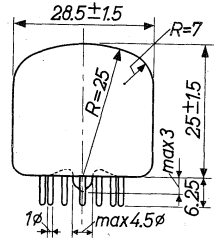
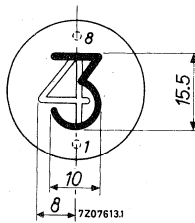
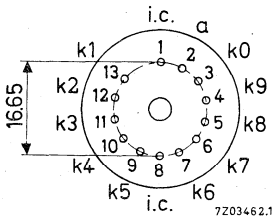

### INDICATOR TUBE

Cold cathode numerical indicator tube for top viewing, electrically identical to type ZM1022 but provided with a decimal point to the left of the numerals.  
The use of a separate amber filter (i.e. blue absorbing) is recommended.

QUICK REFERENCE DATA			
Numeral height		15	mm
Numerals	1 2 3 4 5 6 7 8 9 0		
Decimal point		to the left of the numerals	
Supply voltage	min.	170	V
Anode current, numerals		2	mA
decimal point		0,25	mA

#### DIMENSIONS AND CONNECTIONS

Dimensions in mm

Base: B13B

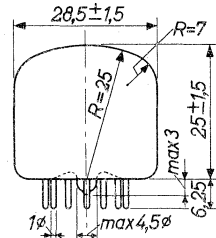
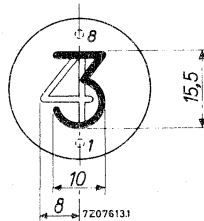
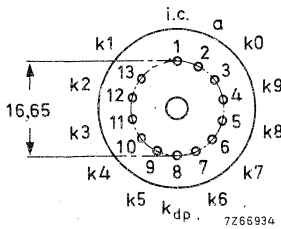

#### CHARACTERISTICS, OPERATING CONDITIONS, AND LIMITING VALUES

For the numerals, are essentially the same as those of type ZM1020.

#### LIMITING VALUES decimal point (Absolute max. rating system)

Anode current, decimal point	max.	0,5	mA
	min.	0,1	mA



# INDICATOR TUBE

The type ZM1023 is electrically identical with type ZM1021 but has no filter coating. The use of a separate amber filter (i. e. blue absorbing) is recommended.

## DIMENSIONS AND CONNECTIONS

Dimensions in mm

Base : B13B

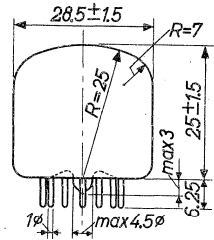
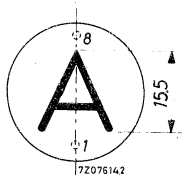
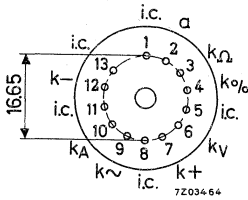



## INDICATOR TUBE

Cold cathode sign indicator tube.

The use of a separate amber filter (i. e. blue absorbing) is recommended.

### QUICK REFERENCE DATA

Sign height	15	mm
Signs	↔ % + -	
Supply voltage	min. 170	V
Anode current	2	mA

### DIMENSIONS AND CONNECTIONS

Dimensions in mm

Base: B13B

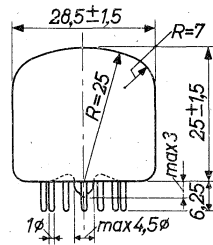
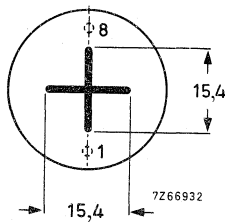
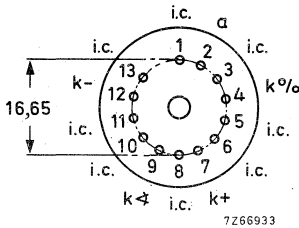

### CHARACTERISTICS, OPERATING CONDITIONS, AND LIMITING VALUES

These are essentially the same as those of type ZM1020.



## INDICATOR TUBE

Cold cathode ten digit numeral indicator tube for side viewing.

QUICK REFERENCE DATA			
Numeral height			30 mm
Numerals	1 2 3 4 5 6 7 8 9 0		
Supply voltage	$V_{ba}$ min.		170 V
Cathode current	$I_k$		4.5 mA

### GENERAL

The numerals are 30 mm high and appear on the same base line allowing in-line read out. The ZM1040 is provided with a red contrast filter.

### PRINCIPLE OF OPERATION

The tube contains ten cathodes in the form of ten figures and one common anode. By applying a suitable voltage between the anode and one of the ten cathodes the corresponding numeral will be covered by a red neon glow.

### DIMENSIONS AND CONNECTIONS

Base: B13B

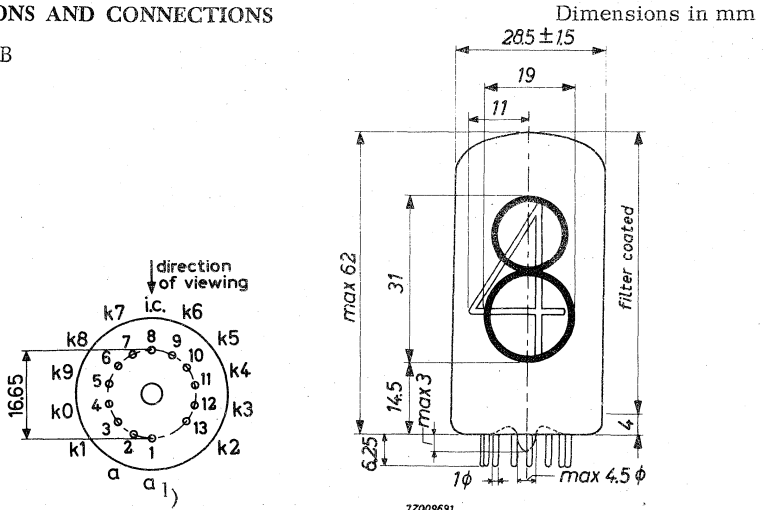

<sup>1</sup>) Pins 1 and 2 to be interconnected externally.

Mounting position: any

The numerals are viewed through the side of the envelope. The numerals will appear upright (within 1.5°) when the tube is mounted vertically.

Accessories

Socket type 2422 505 00001  
or 2422 505 00002

**CHARACTERISTICS AND OPERATING CONDITIONS**

Ignition voltage	$V_{ign}$	max.	170 V
Maintaining voltage	$V_m$	see sheet 5	
Cathode current for coverage, average, during any conduction period	$I_k$	min.	3 mA
Cathode current, average ( $T_{av} = 20$ ms)	$I_k$	max.	6 mA
peak	$I_{kp}$	max.	20 mA
Cathode selecting voltage	$V_{kk}$	see sheet 6	
Extinguishing voltage	$V_{ext}$	min.	120 V

Typical operation at temperatures  $t_{amb} = 10$  to  $50$  °C

D. C. operation with or without  $V_{kk}$

(See fig. 1 and 3 and sheets 5 and 6)

Anode supply voltage	$V_{ba}$	200	250	300	350 V
Maintaining voltage	$V_m$	$140 \pm 10$	$140 \pm 10$	$140 \pm 10$	$140 \pm 10$ V
Anode series resistor	$R_a$	15	27	39	47 k $\Omega$
Cathode selecting voltage	$V_{kk}$			min.	60 V <sup>1)</sup>

A. C. half-wave rectified operation with or without  $V_{kk}$

(See fig. 2 and 4 and sheet 5)

Secondary transformer voltage	$V_{tr}$	170	220	250	300 V
Anode series resistor	$R_a$	5.6	12	18	27 k $\Omega$
Cathode selecting voltage	$V_{kk}$			min.	60 V <sup>1)</sup>

1) With low cathode selecting voltages the current  $I_{kk}$  to the "off" cathodes will increase and the readability of the "on" cathode will be affected. It is therefore recommended to use a voltage  $V_{kk}$  in excess off the stated minimum value.

**LIFE EXPECTANCY** at  $I_k = 4.5 \text{ mA}$

Sequentially changing the display from one digit to the others every 1000 hours or less

100 000 h

**LIMITING VALUES** (Absolute max. rating system)

Anode voltage necessary for ignition	$V_a$	min.	170 V
Cathode current,			
average during any conduction period	$I_k$	min.	3 mA
average ( $T_{av} = 20 \text{ ms}$ )	$I_k$	max.	6 mA
peak	$I_{k_p}$	max.	20 mA
Cathode selection voltage	$V_{kk}$	min.	60 V
Bias voltage between anode and "off" cathodes	$V_{bias}$	max.	120 V
Bulb temperature	$t_{bulb}$	min.	0 °C
		max.	+70 °C <sup>1)</sup>

**SHOCK AND VIBRATION**

An indication for the ruggedness of the tube is the fact that 95% of the items sampled from the normal production line pass the shock and vibration tests specified below without perceptible damage.

Shock: 25  $g_{peak}$ , 1000 shocks in one of the three positions of the tube.

Vibration: 2.5  $g_{peak}$ , 50 Hz, during 32 hours in each of the three positions of the tube.

<sup>1)</sup> Bulb temperatures below 0 °C result in a reduced life expectancy and changes in characteristics (see sheet 7)

In designing equipment to be used over a wide temperature range the use of "constant current operation" (high supply voltage with a high anode series resistor) is recommended.

Fig.1

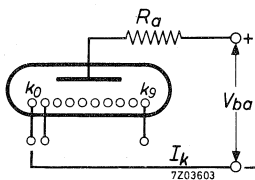

Fig.2

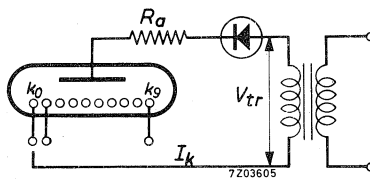

Fig.3

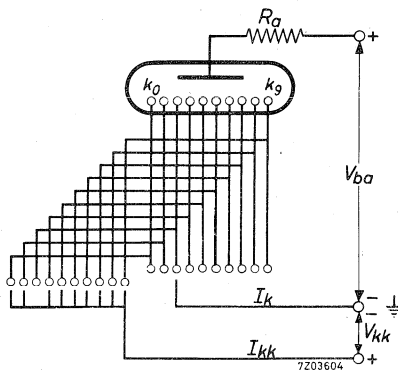
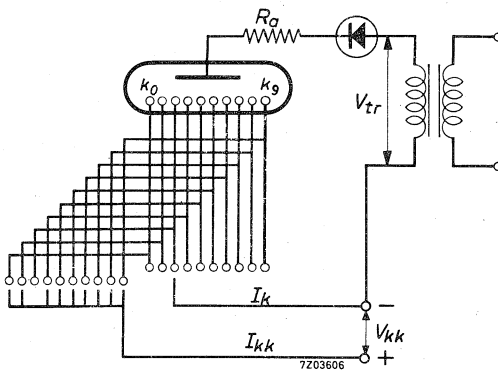
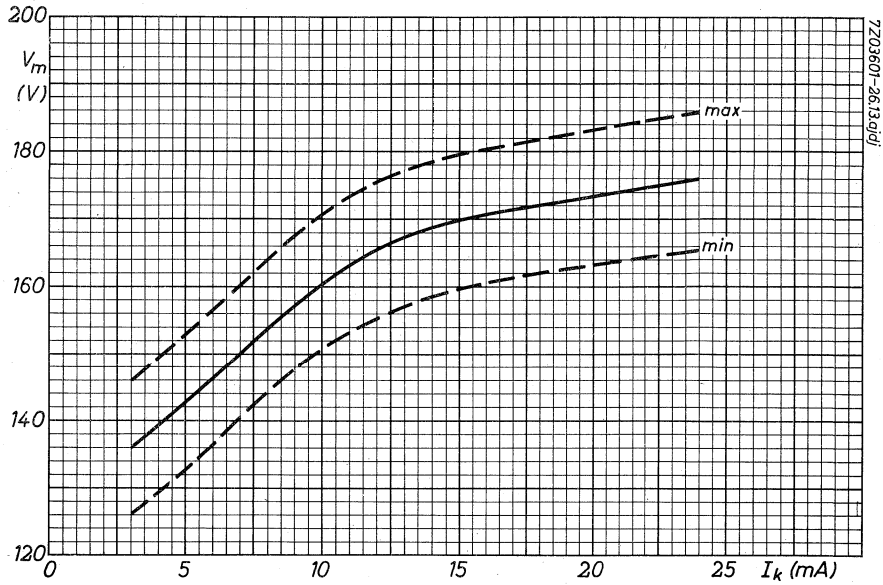
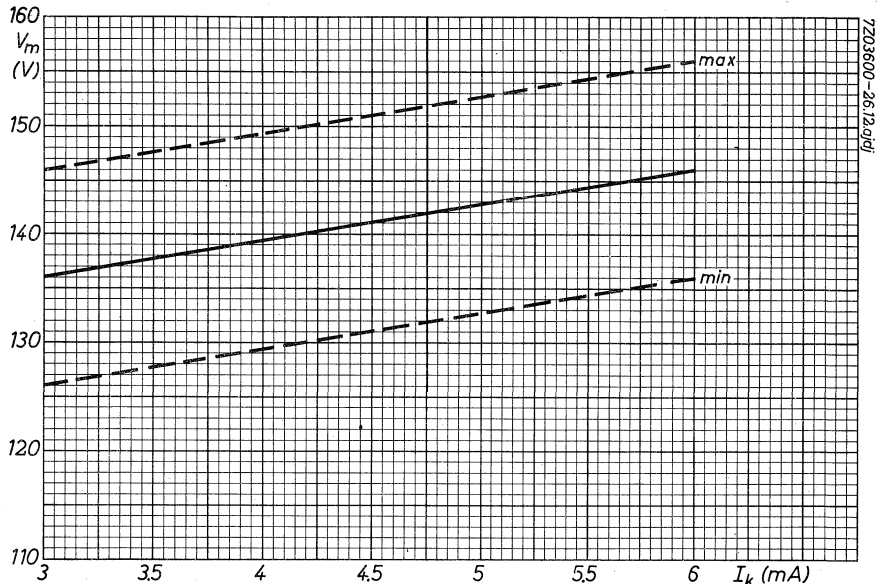
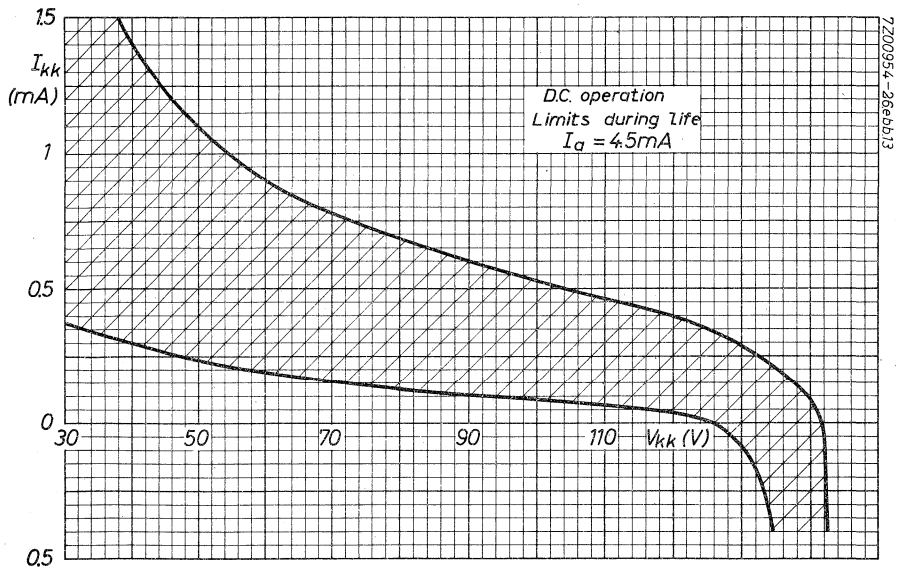
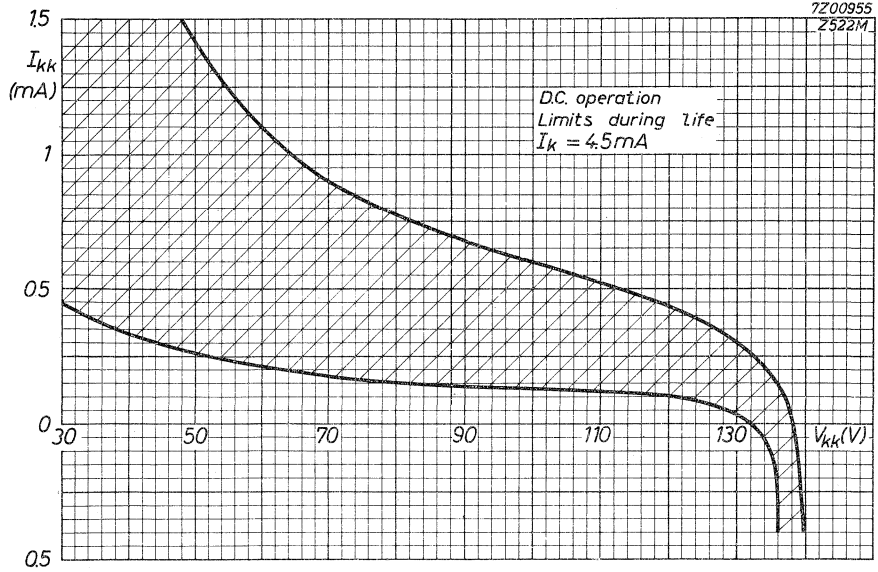

Fig.4









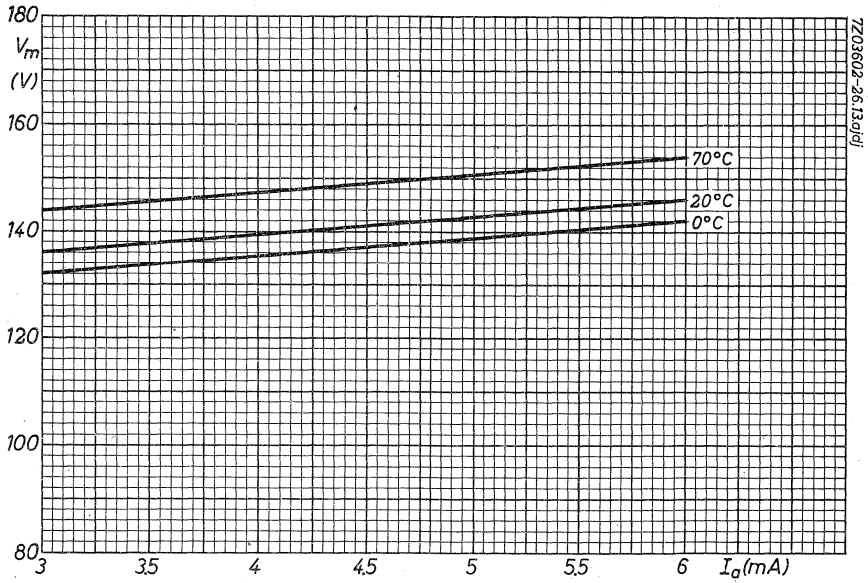



## INDICATOR TUBE

Cold cathode sign indicator tube for side viewing.

QUICK REFERENCE DATA	
Sign height	20 mm
Signs	+ -
Supply voltage	170 V
Cathode current	4.5 mA

### DIMENSIONS AND CONNECTIONS

Dimensions in mm

Base: B13B

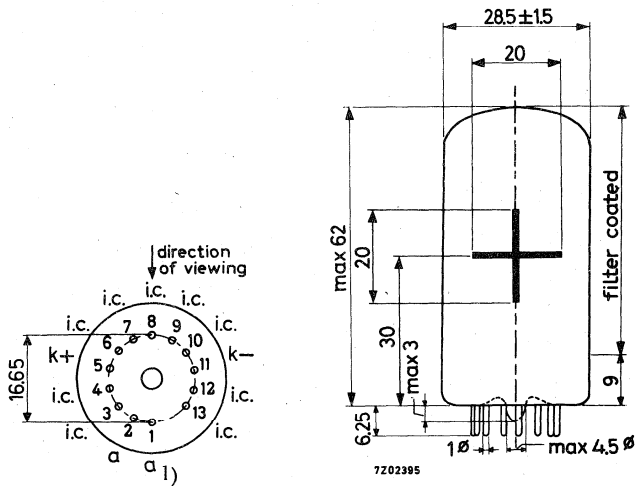

### GENERAL

The tube has the same physical dimensions as the ZM1040 numeral indicator tube. The ZM1041 is provided with a red contrast filter.

1) Pins 1 and 2 to be interconnected externally.

**CHARACTERISTICS**

Ignition voltage	$V_{ign}$	max.	170	V
Maintaining voltage	$V_m$	see sheets 3 and 4		
Extinguishing voltage	$V_{ext}$	min.	120	V
"Off" cathode probe current characteristic		see sheet 4		

**PRINCIPLE OF OPERATION**

The tube contains two cathodes, in the form of the signs + and -, and a common anode. By applying a suitable voltage between the anode and one of the cathodes the corresponding sign will be covered by a red neon glow.

**ACCESSORIES**

Socket 2422 505 00001 or 2422 505 00002

**MOUNTING POSITION**

Any  
The signs are viewed through the side of the envelope.

**LIMITING VALUES** (Absolute max. rating system)

Anode voltage necessary for ignition	$V_a$	min.	170	V
Cathode current,				
average during any conduction period	$I_k$	min.	3	mA
average ( $T_{av} = 20$ ms)	$I_k$	max.	6	mA
peak	$I_{kp}$	max.	20	mA
Impulse duration	$T_{imp}$	min.	80	$\mu$ s
Cathode selecting voltage	$V_{kk}$	min.	60	V
Bias voltage between anode and "off" cathode	$V_{bias}$	max.	120	V
Bulb temperature	$t_{bulb}$	max.	+70	$^{\circ}$ C
		min.	-50	$^{\circ}$ C <sup>1)</sup>

→ **SHOCK AND VIBRATION**

An indication for the ruggedness of the tube is the fact that 95% of the items sampled from the normal production line pass the shock and vibration tests specified below without perceptible damage.

Shock: 25  $g_{peak}$ , 1000 shocks in one of the three positions of the tube.

Vibration: 2.5  $g_{peak}$ , 50 Hz, during 32 hours in each of the three positions of the tube.

<sup>1)</sup> Bulb temperatures below 10  $^{\circ}$ C result in a reduced life expectancy and changes in characteristics (see sheet 4).

In designing equipment to be used within a wide temperature range the use of "constant current operation" (high supply voltage with a high anode series resistor) is recommended.

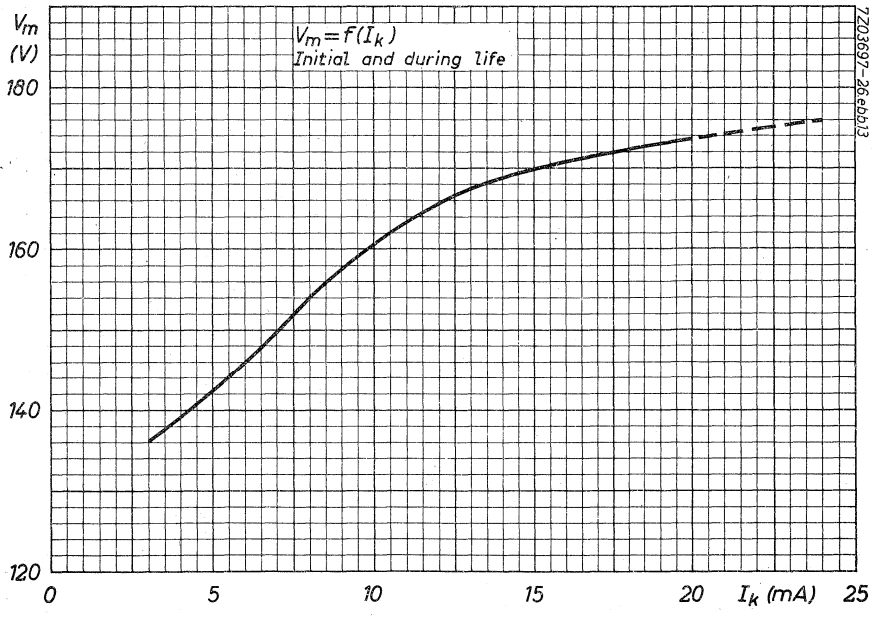
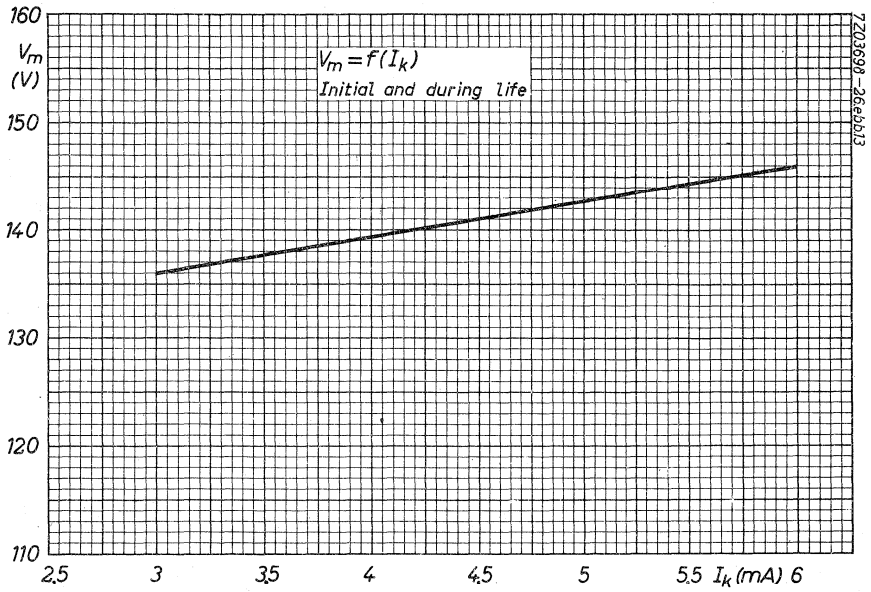

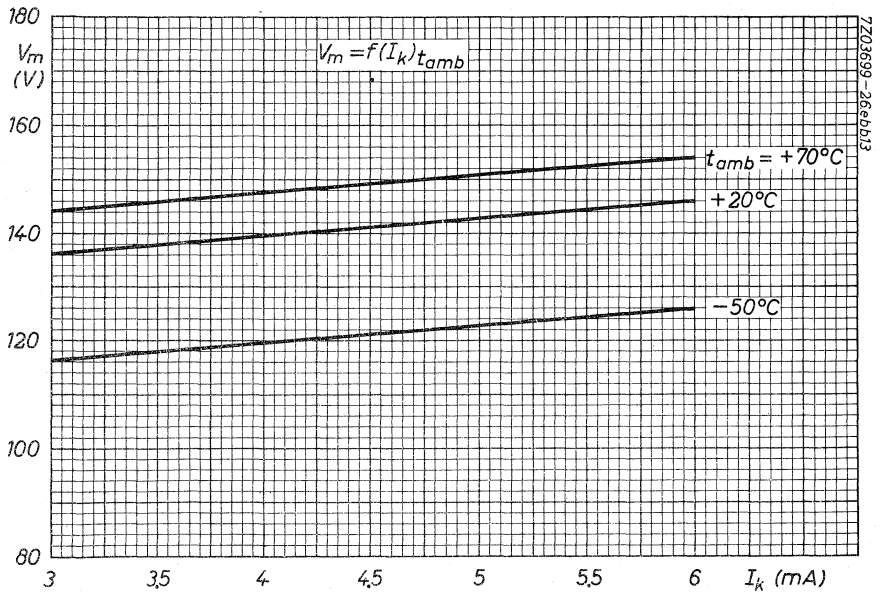



## INDICATOR TUBE

Cold cathode ten digit numeral indicator tube for side viewing.

The types ZM1042 and ZM1042/01 are identical with type ZM1040 but have no filter coating, ; the ZM1042/01 has tinned pins.

The use of a separate blue absorbing, e.g. circular polarized, amber filter is recommended.

### DIMENSIONS AND CONNECTIONS

Dimensions in mm

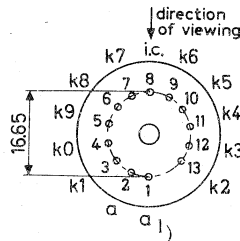
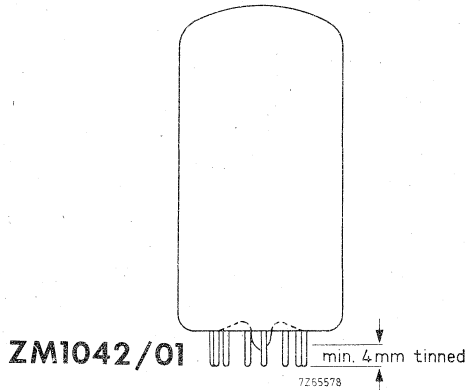

1) Pins 1 and 2 to be connected externally.



## INDICATOR TUBE

Cold cathode sign indicator tube for side viewing.

The types ZM1043 and ZM1043/01 are identical with type ZM1041 but have no filter coating; the ZM1043/01 has tinned pins.

The use of a separate blue absorbing, e.g. circular polarized, amber filter is recommended.

### DIMENSIONS AND CONNECTIONS

Dimensions in mm

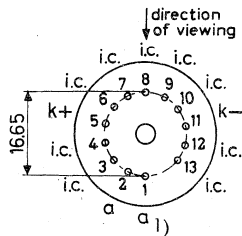
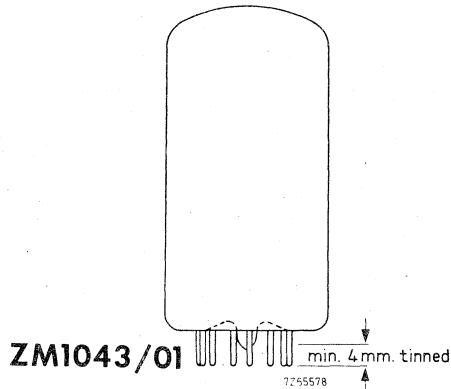

1) Pins 1 and 2 to be connected externally.



# Switching diodes





## SWITCHING AND LIGHT DIODE

Cold cathode neon filled subminiature switching and light diode with a large and stable difference between ignition and maintaining voltage intended for low speed switching and counting e.g. in combination with CdS photo sensitive devices. The tube is shock and vibration resistant.

QUICK REFERENCE DATA		
Ignition voltage	$V_{ign}$	170 V
Maintaining voltage	$V_m$	109 V
Cathode current	$I_k$	3.5 mA

### OPERATING PRINCIPLE

The diode contains a rod shaped molybdenum cathode and a concentric gauze anode. By applying a suitable voltage between the electrodes, a glow discharge occurs and its red light is available outside the tube.

### DIMENSIONS AND CONNECTIONS

Dimensions in mm

Colour type indication on pinch: red dot.

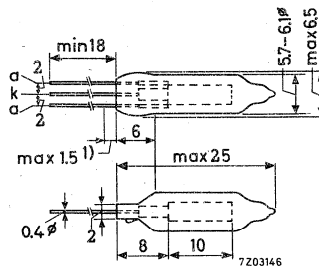

### MOUNTING

The tube may be soldered directly into the circuit but heat conducted to the glass to metal seals should be kept to a minimum by the use of a thermal shunt. The leads may be dip-soldered to a minimum of 5 mm from the seals at a solder temperature of 240 °C during max. 10 s. Care should be taken not to bend the leads nearer than 1.5 mm from the seals.

1) This part of the leads is not tinned.

**CHARACTERISTIC RANGE VALUES FOR EQUIPMENT DESIGN**

(Valid over the first 15000 hours operation within the preferred current range and at  $t_{amb} = \text{room}$ . The electrical characteristics are independent of ambient illumination).

Non conduction

Anode voltage below which ignition will not occur in any tube	$V_{ign \text{ min}}$	163 V
Insulation resistance	$r_{isol}$	> 300 M $\Omega$

Ignition

Anode voltage to ensure ignition	$V_{ign \text{ max}}$	178 V
Ignition delay	See page A and B	
Typical max. individual variation of ignition voltage during life	$\Delta V_{ign}$	< 5 V
Typical temperature coefficient of ignition voltage, averaged over the range -55 °C to +70 °C	$\frac{\Delta V_{ign}}{\Delta t_{bulb}}$	< $\pm 15$ mV/°C

Conduction

Cathode current, average during any conduction period average ( $T_{av} = \text{max. 1 s}$ ) peak (See "Reliability and life expectancy)	$I_k$	> 2.2 mA
	$I_k$	< 4.5 mA
	$I_{kp}$	< 50 mA
Typical rise in bulb temperature	$\frac{\Delta t_{bulb}}{\Delta I_k}$	10 °C/mA
Maintaining voltage	See page A	
Typical max. individual variation of maintaining voltage during life	$\Delta V_m$	< $\begin{matrix} +2 \\ -4 \end{matrix}$ V
Typical max. temperature coefficient of maintaining voltage, averaged over the range -55 °C to +70 °C	$\frac{\Delta V_m}{\Delta t_{bulb}}$	< $\pm 15$ mV/°C
Light intensity <sup>1)2)</sup>	E	> 20 lux/mA
Typical variation of light intensity	$\Delta E$	< -3 %/1000 h

<sup>1)2)</sup> See page 3



Extinction

Typical min. RC components to ensure self extinction at  $V_b = 250$  V for different values of current limiting resistance  $R_d$ .

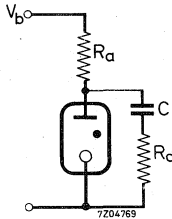

$R_d$	0	1	10	47	100	$k\Omega$
$R_a$	1	1	1.5	2	3	$M\Omega$
C	5	22	22	22	22	nF

RELIABILITY AND LIFE EXPECTANCY

Reliability has been assessed in a life test programme totalling  $5.10^6$  tube hours on 400 tubes. The longest test period being 15000 hours on 100 tubes. A total of 7 failures result in a failure rate of better than 0.15% per 1000 h. This failure rate is not expected to increase over the next period of 15000 h. Life expectancy: 30000 operating hours within the preferred current range or  $2.4 \times 10^6$  ignitions discharging a capacitor of max.  $16 \mu F$  with suitable series impedance to limit the peak current to max. 50 mA.

- 1) Light intensity measured over an angle of  $70^\circ$  at a distance of 3.6 mm from the tube axis opposite the anode cylinder.
- 2) Measured with a Standard Weston Cell adopted to eye sensitivity. Because the light emission of the neon discharge is mainly contained in the red region, the illumination resistance of a CdS cell will be 1.5 to 2 times lower than in case of irradiation by a  $2700^\circ K$  incandescent light source. The exact conversion factor depends on the type of CdS cell used.

**LIMITING VALUES** (Absolute max. rating system)

Cathode current, average for continuous conduction	$I_k$	min. 2.2 mA <sup>1)</sup>
		average ( $T_{av} = \text{max. } 1 \text{ s}$ )
	$I_k$	max. 4.5 mA <sup>1)</sup>
	peak	$I_{k_p}$ max. 50 mA
Anode voltage, negative peak	$-V_{ap}$	max. 200 V
Bulb temperature	$t_{bulb}$	min. $-55 \text{ }^\circ\text{C}$
		max. $+70 \text{ }^\circ\text{C}$
Altitude	$h$	max. 24 km

**SHOCK AND VIBRATION RESISTANCE**

These conditions are solely used to assess the mechanical quality of the tube. The tube must not be continuously operated under these conditions.

Shock resistance 500 g

Forces as applied by the NRL impact machine for electronic devices caused by 5 blows of the hammer lifted over an angle of  $30^\circ$  in each of 4 positions of the tube.

Vibration resistance 2.5 g(peak)

Vibrational forces for a period of 32 hours at a frequency of 50 Hz in each of 3 directions.

<sup>1)</sup> Current excursions down to 1 mA and up to 5 mA are permitted under conditions of e.g. extreme supply voltage variations. The excursion times should preferably be as short as possible but never exceed 24 hours.

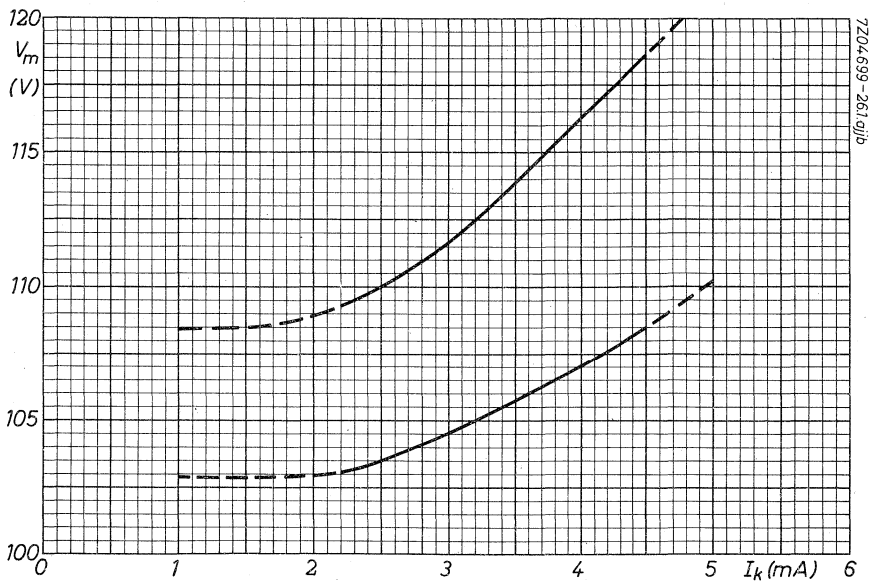
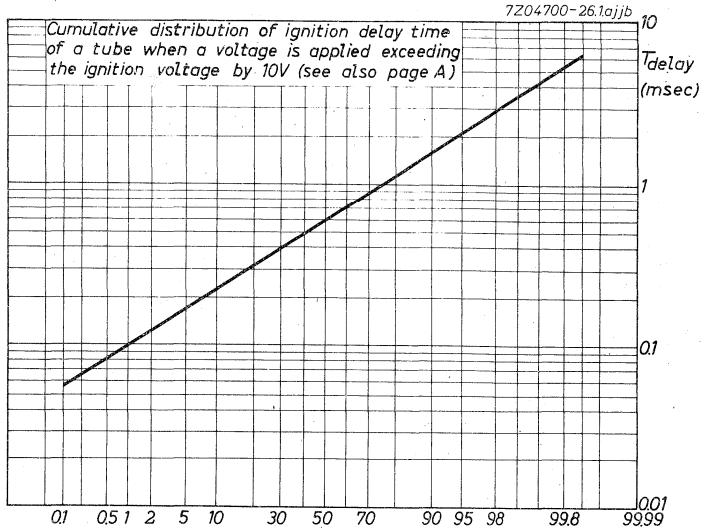

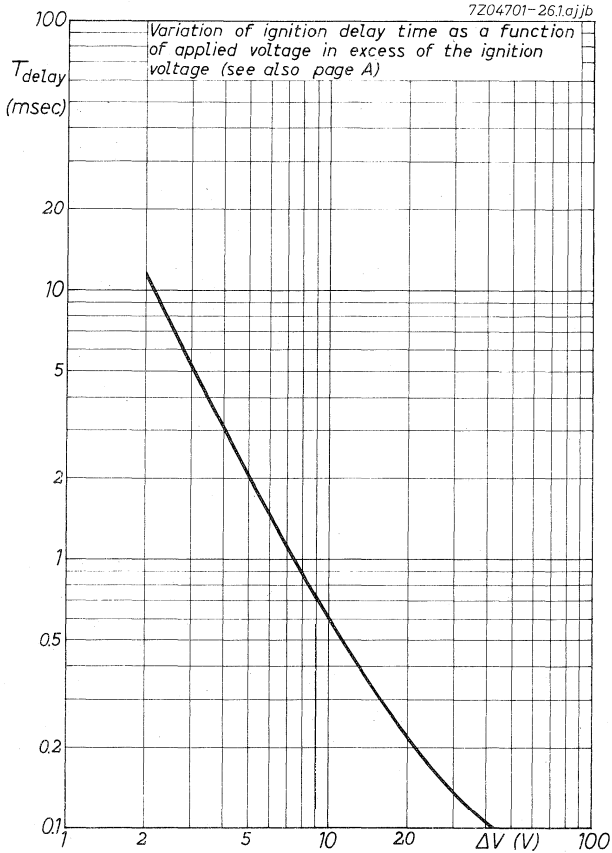

## GAS FILLED INDICATOR DIODE

Shock and vibration resistant cold-cathode gas-filled subminiature diode with visible glow-discharge for read-out purposes.

The tube contains two electrodes, a rod shaped molybdenum cathode and a concentric gauze anode.

### APPLICATION

Indicator in low voltage transistor circuits. The diode can be used in combination with CdS photoconductive cells and it can be controlled by voltage signals down to 3 V.

QUICK REFERENCE DATA	
Ignition voltage	$V_{ign} = 90 \text{ V}$
Extinction voltage	$V_{ext} > 83.5 \text{ V}$
Cathode current	$I_k = 1 \text{ mA}$
Light intensity at $I_k = 1 \text{ mA}$	$E = 60 \text{ lux}$

### MECHANICAL DATA

Type indication on pinch: yellow dot.

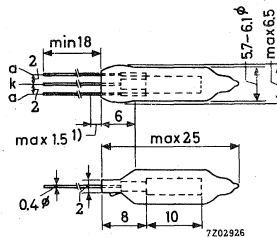

Dimensions in mm

### MOUNTING

The tube may be soldered directly into the circuit, but heat conducted to the glass-to-metal seals should be kept to a minimum by the use of a thermal shunt. The leads may be dip-soldered to a minimum of 5 mm from the glass-to-metal seals at a solder temperature of 240 °C during max. 10 seconds.

If the tube is held in its position by the leads only, the connection of both anode leads is recommended.

Care should be taken not to bend the leads nearer than 1.5 mm from the seals.

<sup>1)</sup> Not tinned

**SHOCK AND VIBRATION RESISTANCE**

These conditions are solely used to assess the mechanical quality of the tube. The tube must not be continuously operated under these conditions.

Shock resistance 500 g.

Forces as applied by the NRL impact machine for electronic devices caused by 5 blows of the hammer lifted over an angle of 30° in each of 4 positions of the tube.

Vibration resistance 2.5 g (peak)

Vibrational forces for a period of 32 hours at a frequency of 50 Hz in each of 3 directions.

**CHARACTERISTICS**

Valid over 15000 operating hours within the preferred current range and at room temperature unless otherwise stated.

The electrical characteristics are independent of ambient illumination.

Non conduction

Anode voltage below which ignition will not occur in any tube	$V_{ign\ min.}$	=	88 V
Insulation resistance	$r_{isol}$	>	300 MΩ

Ignition

Ignition voltage, upper limit	$V_{ign\ max.}$	=	93 V	1)
individual variation during life	$\Delta V_{ign}$	<	2.5 V	
Ignition delay at $V_{ba} = 93\ V$	$T_{delay}$	≈	0.05 s	2)
Temperature coefficient of ignition voltage	$\frac{\Delta V_{ign}}{\Delta t_{bulb}}$	<	-15 mV/°C	3)
Reignition voltage in case of full wave rectified a.c. supply	$V_{reign}$	<	101 V	4)
		>	96.5 V	4)

- 1) The ignition and extinction voltage depression (hysteresis) is max. 0.75 V per mA prior current measured 50 ms after cessation of conduction.
- 2) Due to the statistical nature of ignition delay values of delay time > 1 s may occasionally occur.
- 3) Characteristic range value for equipment design.
- 4) These values apply to 220 V (+10 %, -15 %), 50 Hz to 60 Hz full-wave rectified unsmoothed supply and assume conduction in the course of the preceding half cycle, so that residual ionization eliminates delay of the following ignition.

**CHARACTERISTICS** (continued)

Conduction

Cathode current,

preferred range  $I_k = 0.4 \text{ to } 2 \text{ mA}$  <sup>5)</sup>

peak  $I_{kp} = 3 \text{ mA}$

Maintaining voltage  $V_m < 86 \text{ V} + 4.25 \text{ V/mA}$  <sup>6)</sup>  
 $V_m > 83 \text{ V} + 2.5 \text{ V/mA}$  <sup>7)</sup>

Individual variation during life  $\Delta V_m < 1.5 \text{ V}$

Temperature coefficient of maintaining voltage  $\frac{\Delta V_m}{\Delta t_{bulb}} < -15 \text{ mV/}^\circ\text{C}$  <sup>3)</sup>

Rise in bulb temperature  $\frac{\Delta t_{bulb}}{\Delta I_k} = 10 \text{ }^\circ\text{C/mA}$

Light intensity,  $E > 30 \text{ lux/mA}$  <sup>8) 9)</sup>

individual minimum, measured over an angle of  $70^\circ$  averaged over the full circumference of the tube  $E_{av} > 60 \text{ lux/mA}$  <sup>8) 9)</sup>

Extinction

Extinction voltage  $V_{ext} > 83.5 \text{ V}$  <sup>1)</sup>

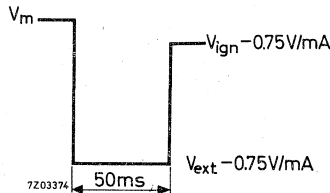

See note 1) page 2

- 5) Current excursions during ignition and extinction are not taken into account.
- 6) Valid within the range 0.1 mA to 3 mA.
- 7) Valid within the range 0.2 mA to 3 mA. Between 0.05 mA and 0.2 mA  $V_{m \text{ min.}} = V_{ext} = 83.5 \text{ V}$ .
- 8) Light intensity at a distance of 3.6 mm from the tube axis opposite the anode cylinder, measured with a standard Weston cell adopted to eye sensitivity. Because the emission of the neon discharge is mainly contained in the red region the illumination resistance of a CdS cell will be 1.5 to 2 times lower than in case of irradiation by a 2700 °K incandescent light source. The exact conversion factor depends on the type of CdS cell used.
- 9) At least 90% of the tubes will meet the figure stated.

**RELIABILITY AND LIFE EXPECTANCY**

The electrical characteristics have been assessed in a life test programme, totalling  $3.0 \times 10^6$  tube hours with no failures, denoting a failure rate of better than 0.1 % per 1000 hours. The maximum test period was 19000 hours on 22 tubes. This failure rate is not expected to increase over the first 25000 hours of continuous operation within the preferred current range.

**LIMITING VALUES** (Absolute maximum rating system)

Cathode current, averaging time = 5 s	$I_k$	= max.	2.5 mA
Cathode current during conduction	$I_k$	= min.	0.1 mA <sup>1)</sup>
Cathode current, peak	$I_{kp}$	= max.	3 mA
Anode voltage, negative peak	$-V_{ap}$	= max.	70 V
Bulb temperature		= min.	-55 °C
	$t_{bulb}$	= max.	70 °C + 10 °C/mA
Altitude	$h$	= max.	24 km

**READ-OUT CIRCUIT BISTABLE MULTIVIBRATORS**

Principle of operation

The figures 1 and 2 show equivalent circuits for bistable multivibrators, equipped with p-n-p- and n-p-n transistors respectively, to which a read-out circuit has been added. The transistors are replaced by ideal switches, the voltage source  $V_T$  represents the available voltage that controls the diodes 2) and  $R_T$  is the output resistance as measured at the collector of the cut-off transistor.

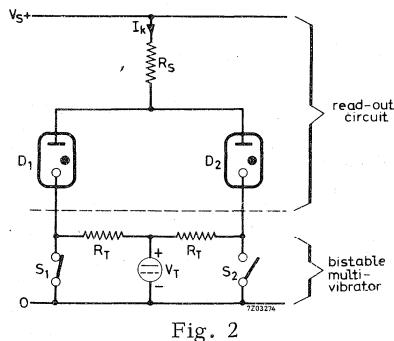
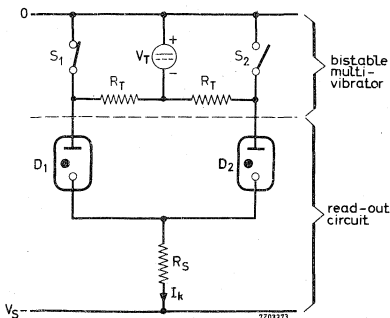

<sup>1)</sup> Current excursions down to 50  $\mu$ A with a duration < 1 s are permitted.

<sup>2)</sup>  $V_T = V_{C.o.} - V_{sat}$  (V) in which  
 $V_{C.o.}$  = voltage between collector of the cut-off transistor and the common terminal (absolute value).

$V_{sat}$  = voltage across the bottomed transistor (absolute value).



### READ-OUT CIRCUIT BISTABLE MULTIVIBRATORS (continued)

Correct read-out is obtained when only the diode corresponding to the bottomed transistor conducts. For this the following conditions must be met: <sup>1)</sup>

- (I) Ignition of the correct diode, corresponding to the bottomed transistor, when the other diode is conducting.

$$\text{Thus: } V_{m \text{ min.}} + I_k R_T + V_T > V_{\text{ign max.}},$$

$$\text{resulting in } I_k > \frac{10 - V_T}{R_T + 2.5} \frac{(V)}{(k\Omega)} \text{ for } I_k > 0.2 \text{ mA}$$

- (II) Extinction of the diode corresponding to the cut-off transistor, when the correct diode is conducting.

$$\text{Thus: } V_{m \text{ max.}} - V_T < V_{\text{ext min.}},$$

$$\text{resulting in } I_k < \frac{V_T - 2.5}{5} \frac{(V)}{(k\Omega)} \text{ for } I_k > 0.1 \text{ mA}$$

- (III) Non-ignition of the diode corresponding to the cut-off transistor when the correct diode is conducting.

$$\text{Thus: } V_{m \text{ max.}} - V_T < V_{\text{ign min.}},$$

$$\text{resulting in } I_k < \frac{V_T + 2}{5} \frac{(V)}{(k\Omega)} \text{ for } I_k > 0.1 \text{ mA}$$

These conditions are shown graphically on page A below.

#### Condensed instructions for designing the read-out circuit. 2)

The following directives are based on the requirement that correct read-out shall be ensured under worst case conditions, after the instant that the bistable circuit has reached its final stationary state. It is irrelevant whether the read-out diodes follow the changes of state of the multivibrator during its dynamic operation or not.

A choice can be made between the following modes of operating the diodes, namely by means of:

- (A) a constant direct current
- (B) a constant direct current on which a pulse is superimposed prior to reading-out. Three kinds of pulses are possible:
  - a) a positive going pulse;
  - b) a negative going pulse;
  - c) a positive going pulse followed by a negative going one
- (C) an unsmoothed current supplied by a full wave rectifier.

<sup>1)</sup> It is assumed that the supply voltage  $V_s$  exceeds the ignition voltage of the gas diodes, so that ignition of at least one diode is ensured; the most adverse situation being that only the wrong diode conducts.

2) For a detailed analysis of the design procedure please apply to the manufacturer.

READ-OUT CIRCUIT BISTABLE MULTIVIBRATORS (continued)

In fig. 3, schematically representing these waveforms, the required minimum duration of the superimposed pulses is indicated;  $t_s$  denotes the instant at which the bistable circuit reaches its final state.

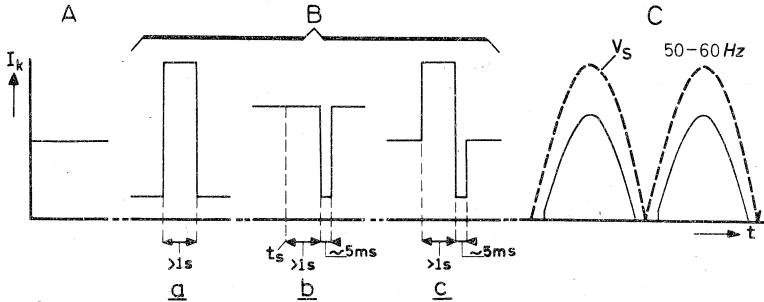

Fig. 3

The conditions to be obeyed by the current  $I_k$  are specified in the table below :

Mode of operation	Values of $I_k$		$V_T$
	lower limit	upper limit	
(A) constant direct current	(I)	(II)	$> 5 V$
(B) direct current with superimposed:			
(a) positive going pulses	{ steady state current (I)	{ (II) -	} $> 4.5 V$
(b) negative going pulses	{ steady state current -	{ (III) (II)	
(c) positive and negative going pulses	{ steady state current (I) -	{ (III) - (II)	} $> 3 V$
(C) rectified alternating current, peak value of $I_k$	(I)	(III)	

This table should be read in conjunction with the specified recommended operating conditions and limiting values.

1) Since both diodes are extinguished at the end of each half cycle of the supply voltage, condition (II) is not required, and is replaced by the condition that only the correct diode will reignite. The lower limit is thus given by the spread of the reignition voltage (e.i. 4.5 V).

**READ-OUT CIRCUIT BISTABLE MULTIVIBRATORS** (continued)

The minimum available value of  $V_T$  being known, the points of intersection with the curves I, II and III on page 8, and hence the limits of  $I_k$  ( $I_{kI}$ ,  $I_{kII}$  and  $I_{kIII}$ ) can be determined. This having been done, the required values of  $V_{Smin}$  and  $R_S$  can be evaluated from the following expressions: <sup>1)</sup>

$$\frac{V_{Smin} - V_{ign\ max}}{R_{S\ max}} = I_{kI} \quad (1)$$

$$\frac{V_{Smax} - V_{ext\ min} - V_T}{R_{S\ min}} = I_{kII} \quad (2)$$

$$\frac{V_{Smax} - V_{ign\ min} - V_T}{R_{S\ min}} = I_{kIII} \quad (3)$$

In these expressions the suffices min and max denote the worst case limits of the quantities concerned.

For mode of operation (C) the peak value of the supply voltage must be substituted for  $V_S$  in the above expressions.

<sup>1)</sup> The use of equivalent circuits for establishing the exact conditions I, II, and III leads to a negligible error in the expressions (1), (2) and (3).

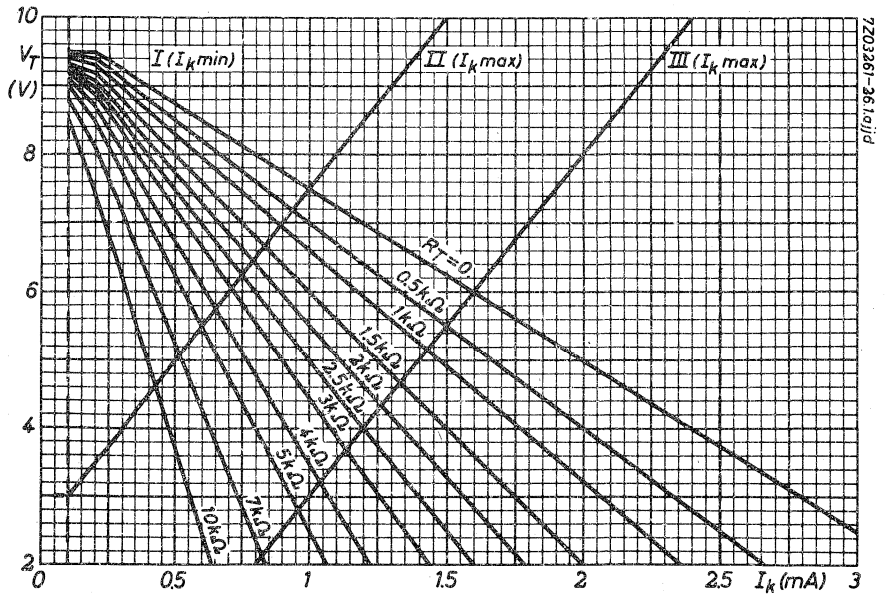
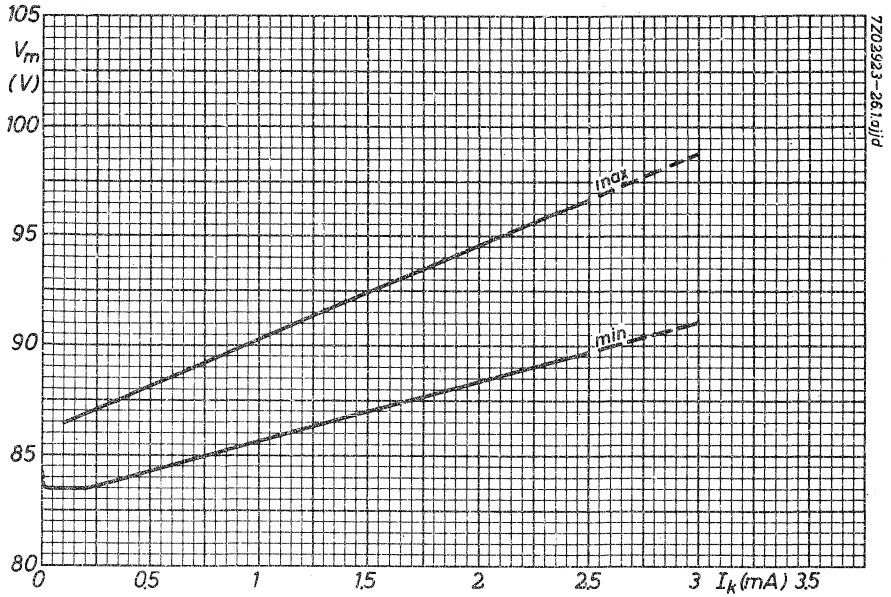

## SWITCHING AND LIGHT DIODE

Long-life cold-cathode neon-filled subminiature switching and light diode with a large and stable difference between ignition and maintaining voltage intended for touch control applications e. g. in variable capacitance diode controlled radio or television tuners. The tube is shock and vibration resistant.

QUICK REFERENCE DATA			
Ignition voltage	$V_{ign}$	172	V
Maintaining voltage	$V_m$	107	V
Cathode current	$I_k$	3	mA

### DIMENSIONS AND CONNECTIONS

Dimensions in mm

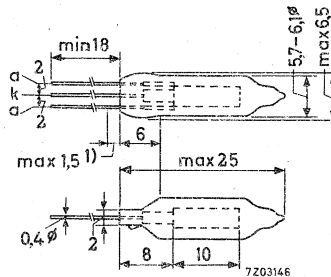

### MOUNTING

The tube may be soldered directly into the circuit, but heat conducted to the glass to metal seals should be kept to a minimum by using a thermal shunt. The leads may be dip-soldered to a minimum of 5 mm from the seals at a solder temperature of 240 °C during max. 10 s. Care should be taken not to bend the leads closer than 1,5 mm to the seals.

1) This part of the leads is not tinned.

**CHARACTERISTICS AND OPERATING CONDITIONS**

Valid over life and full temperature range unless otherwise stated.  
 The electrical characteristics are independent of ambient illumination.

Non conduction

Anode voltage below which ignition will not occur	$V_{ignmin.}$	>	161	V
Insulation resistance	$r_{ins}$	>	300	MΩ

Ignition

Anode voltage to ensure ignition	$V_{ignmax.}$	>	183	V
Ignition delay at $V_{ign} + 10$ V	$T_{delay}$	<	50	ms
at $V_{ign} + 20$ V	$T_{delay}$	<	20	ms
Typical max. individual variation of ignition voltage during life, within the $V_{ign}$ limits given above	$\Delta V_{ign}$	<	5	V

Conduction

Cathode current, average during any conduction period average ( $T_{av} = \text{max. } 1 \text{ s}$ )	$I_k$	>	2, 2	mA
	$I_k$	<	4, 5	mA
Maintaining voltage at $I_k = 3 \text{ mA}$	$V_m$	$\approx$	103	V
	$V_m$	$\leq$	111	V
Typical max. individual variation of maintaining voltage during life, within the $V_m$ limits given above	$\Delta V_m$	<	+2	V
	$\Delta V_m$	<	-4	V

Extinction

Extinction voltage	$V_{ext}$	>	100	V
--------------------	-----------	---	-----	---

**LIMITING VALUES** (Absolute max. rating system)

Cathode current, average for continuous conduction average ( $T_{av} = \text{max. } 1 \text{ s}$ )	$I_k$	min.	2, 2	mA
	$I_k$	max.	4, 5	mA
Anode voltage, negative peak	$-V_{ap}$	max.	200	V
Bulb temperature	$t_{bulb}$	min.	-55	$^{\circ}\text{C}$
		max.	+70	$^{\circ}\text{C}$

**SHOCK AND VIBRATION RESISTANCE**

These conditions are solely used to assess the mechanical quality of the tube. The tube must not be continuously operated under these conditions.

Shock resistance 500 g

Forces as applied by NRL impact machine for electronic devices caused by 5 blows of the hammer lifted over an angle of  $30^{\circ}$  in each of 4 positions of the tube.

Vibration resistance 2, 5 g(peak)

Vibrational forces for a period of 32 hours at a frequency of 50 Hz in each of 3 directions.





## Dry reed contact units





## **GENERAL**

### **REED CONTACT UNITS**

#### **Definitions**

##### Reed contact unit

A reed contact unit is an assembly containing contact blades, some or all of magnetic material, sealed in an envelope.

##### Must-not-operate value

The must-not-operate value is the stated limit of the magnetic field at which the reed contact unit shall not physically operate.

##### Must-operate value

The must-operate value is the stated limit of the magnetic field at which the reed contact unit shall physically operate.

##### Operate time

The operate time is the time between the instant of the application of a specified magnetic field to a specific contact circuit and the instant of the first physical closing (or opening) of this specific contact circuit. The operate time does not include bounce time (unless otherwise indicated).

##### Bounce

Bounce is a momentary reopening of a contact after initial physical closing, or a momentary reclosing after initial physical opening.

##### Bounce time

The bounce time is the interval of time between the instant of first physical closing (or opening) and the instant of the final physical closing (or opening) of a specific contact circuit).

##### Contact circuit

A contact circuit is the whole of the electrically conductive parts of a reed contact unit which are intended to be connected in an external circuit.

##### Characteristic non-release value

The characteristic non-release value is the stated value of the magnetic field above which the operated reed contact unit fulfills specified qualities, e.g. contact resistance, noise characteristics etc.

# GENERAL

## Reed contact units

### Contact circuit resistance (also contact resistance)

The contact circuit resistance is the resistance of the contact circuit under specified conditions of measurement.

### Must-not-release value

The must-not-release value is the stated limit of the applied magnetic field at which the operated reed contact unit shall remain physically operated.

### Must-release value

The must-release value is the stated limit of the magnetic field at which the operated reed contact unit shall physically release.

### Release time

The release time is the time between the instant of the disconnection of a specific magnetic applied field to a specific contact circuit and the instant of the first opening (or closing) of this specific contact circuit. The release time does not include bounce time.

### Saturation

The saturation is the magnetic condition, arbitrarily defined, at which the performance of the reed contact unit is unaffected by further increase of the applied magnetic field.

### Saturate value

The saturate value is the arbitrarily defined value of the magnetic field at which the reed contact unit reaches saturation.

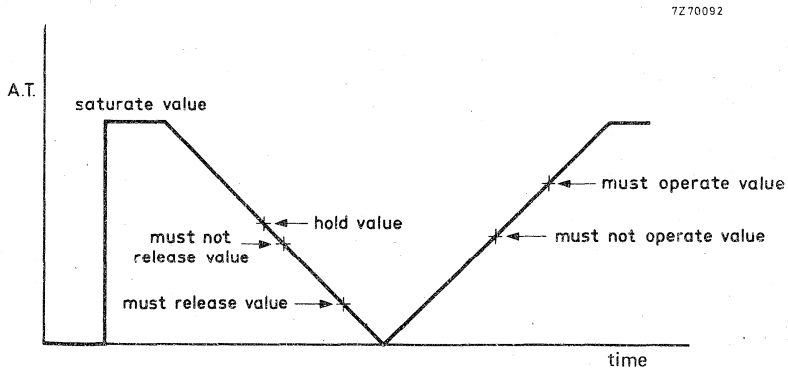

## DRY REED SWITCH

Miniature dry reed switch hermetically sealed in a glass-filled glass capsule. Single-pole, single-throw type, having normally open contacts, and containing two magnetically actuated reeds. The switch is of the double-ended type and may be actuated by means of either an electromagnet or a permanent magnet or combinations of both. The switch is intended for use in telephone equipment and other applications where exceptional reliability is required.

### QUICK REFERENCE DATA

Contact	S. P. S. T. normally open
Switched power	max. 5 W
Switched voltage	max. 65 V
Switched current	max. 100 mA
Failure rate	$< 5 \times 10^{-8}$

### MECHANICAL DATA

Contact material	gold	Dimensions in mm
Contact arrangement	normally open	
Terminal finish	tinned	
Resonant frequency of single reed	approx. 1650 Hz	
Net weight	approx. 0.6 g	
Mounting position	any	

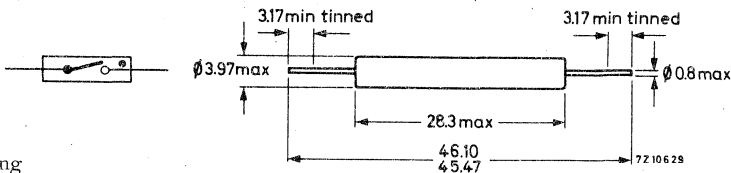

### Mounting

The leads should not be bent nearer than 2 mm to the glass-to-metal seals. Stress on the glass-to-metal seals should be avoided.

The robustness of terminations is tested according to IEC Publication 68-2-21. test Ua (load 2.75 kg), Ub (load 1 kg, 2 bends), and Uc.

Care must be taken to prevent stray magnetic fields from influencing the operating and measuring conditions.

Soldering

The switch may be soldered direct into the circuit but heat conducted to the glass-to-metal seals should be kept to a minimum by the use of a thermal shunt.

Dip-soldering is permitted to a minimum of 4 mm from the seals at a solder temperature of 240 °C during maximum 10 s.

Solderability

Solderability is tested according to IEC Publication 68-2-20, test T, solder globule method.

**CHARACTERISTICS**

Non-operative

Breakdown voltage	min.	1000	V
Insulation resistance, initial (V = 100 V)	min.	10 <sup>5</sup>	MΩ
Capacitance without test coil		0.70	pF
Capacitance with earthed test coil		0.35	pF
Non-operative ampere turns	max.	30	A.T. <sup>1)</sup>

Operative

Operating ampere turns	max.	58	A.T. <sup>1)</sup>
Operating time, including bounce	av.	0.6	ms <sup>1)2)</sup>
	max.	1.0	ms <sup>1)2)</sup>
Switched current	max.	100	mA

Hold

Hold ampere turns	min.	27	A.T. <sup>1)</sup>
Current through closed contacts	max.	1	A
Contact resistance, initial	min.	60	mΩ <sup>1)3)</sup>
	max.	150	mΩ <sup>1)3)</sup>

Release

Release ampere turns	max.	15	A.T. <sup>1)</sup>
Release time	max.	50	μs <sup>1)2)</sup>
Switched current	max.	100	mA
Switched power	max.	5	W

1) Measured in a standard coil of 5000 turns of 42 SWG single enamelled copper wire on a coil former of 25.4 mm winding length and a core diameter of 8.75 mm.

2) Measured with 80 A.T.

3) Measured with 40 A.T.

**LIMITING VALUES** (Absolute max. rating system)

See also "Life expectancy and reliability"

Switched power	max.	5	W
Switched voltage	max.	65	V
Switched current	max.	100	mA
surge (T = max. 100 ns)	max.	1.5	A
Temperature, operating	min.	-55	°C
	max.	+80	°C

**LIFE EXPECTANCY AND RELIABILITY**

End of life is assumed to be reached when:

- a) the contact resistance exceeds 1 Ω for no load conditions or 2.5 Ω for loaded conditions
- b) the release time exceeds 2.5 ms (latching or contact sticking)

No load conditions

Life expectancy min.  $10^7$  operations with a failure rate of less than  $5.5 \times 10^{-9}$  with 90% confidence level.

Loaded conditions

Life expectancy min.  $5 \times 10^6$  operations with a failure rate of less than  $10^{-8}$  with 90% confidence level.

If inductive loads are to be interrupted, contact protection is recommended (diode or RC network).

Reliability - testing conditions

Capacitive loading resulting in a peak current of 0.8 A  $i_1/i_2 = 1.4$ , T = 80 ns to 100 ns, see Fig. 1. Nominal switched voltage 50 V, nominal switched current 100 mA.

Under these conditions a life of more than  $5 \times 10^6$  operations can be reached with a failure rate of less than  $8.5 \times 10^{-9}$ .

Remark

Higher loads may be switched if a reduced life expectancy and reliability are acceptable. The manufacturer should be consulted before doing so.

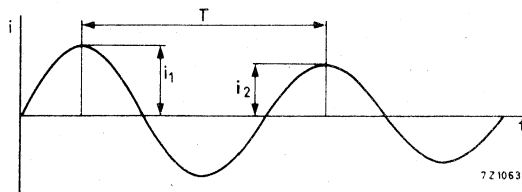

Fig. 1

**SHOCK AND VIBRATION**

Impact : Acceleration 50 g during 11 ms, due to a force perpendicular to the flat sides of the reeds.

Such an impact will not cause an open contact (no magnetic field present) to close, nor a contact kept closed by an 80 A. T. coil to open.

Vibration: Frequency range 50 Hz to 1500 Hz, acceleration 20 g due to a force perpendicular to the flat side of the reed.

Such a vibration will not cause an open contact (no magnetic field present) to close, nor a contact kept closed by an 80 A. T. coil to open.



## DRY REED CONTACT UNIT

Micro dry reed contact unit hermetically sealed in a gas-filled glass capsule. Single-pole, single-throw type, having normally open contacts, and containing two magnetically actuated reeds. The contact unit is of the double-ended type and may be actuated by means of either an electromagnet or a permanent magnet or combinations of both. The device is intended for use in push buttons, relays or in similar devices, in conjunction with semiconductor devices.

### QUICK REFERENCE DATA

Contact	S.P.S.T. normally open		
Switched power	max.	10	W
Switched voltage , d.c.	max.	150	V
	a.c. (r.m.s.)	max.	110 V
Switched current , d.c. or a.c. (r.m.s.)	max.	500	mA
Contact resistance (initial)		140	mΩ
The RI-20 series comprises the types RI-20/3A, RI-20/3B, and RI-20/3C with the following basic magnetic characteristics, measured with the Standard coil.			
	RI-20/3A	RI-20/3B	RI-20/3C
Operate range (A t)	20 to 32	28 to 52	46 to 70
Release range (A t)	8 to 22	12 to 32	12 to 32

### MECHANICAL DATA

Dimensions in mm

Contact arrangement	normally open
Lead finish	tinned
Resonant frequency of single reed	approx. 2900 Hz
Net mass	approx. 0,16 g
Mounting position	any

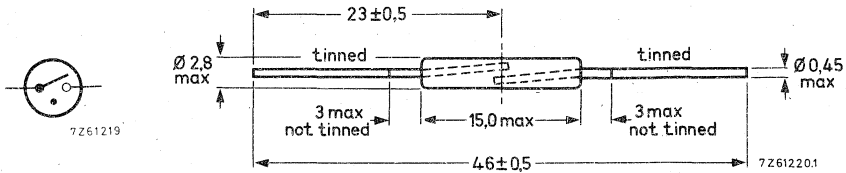

### Mechanical strength

The robustness of terminations is tested according to IEC Publication 68-2-21, test Ua (load 2 kg), Ub (load 0,5 kg, 2 bends), and Uc (3 x 360°).

### Mounting

The leads should not be bent nearer than 1 mm to the glass-to-metal seals.

Stress on the seals should be avoided.

Care must be taken to prevent stray magnetic fields from influencing the operating and measuring conditions.

## Soldering

The contact unit may be soldered direct into the circuit but heat conducted to the glass-to-metal seals should be kept to a minimum by the use of a thermal shunt.

Dip-soldering is permitted to a minimum of 3 mm from the seals at a solder temperature of 240 °C during maximum 10 s.

## Solderability

Solderability is tested according to IEC Publication 68-2-20, test T, solder globule method.

## Weldability

The leads are weldable.

The RI-20 SERIES comprises three types: RI-20/3A, RI-20/3B, and RI-20/3C.

## **CHARACTERISTICS RI-20/3A**

### Not-operate

Breakdown voltage	min.	400	V
Insulation resistance, initial	min.	10 <sup>3</sup>	MΩ
Capacitance, without test coil	max.	0,25	pF

		coil I	coil II	coil III	1)
Must-not-operate value	max.	20	13	18	At
<u>Operate</u>					
Must-operate value	max.	32	18	26	At
Operate time, including bounce	typ.	0,5	2)		ms
	max.	1,0	2)		ms
Bounce time	typ.	0,4	2)		ms
	max.	0,7	2)		ms
Contact resistance, initial	typ.	140	3)		mΩ
	max.	300	3)		mΩ
<u>Not-release</u>					
Must-not-release value	min.	22	13	18	At
<u>Release</u>					
Must-release value	max.	8	6	8	At
Release time	max.	50	2)		μs

Notes: see page 3.

**CHARACTERISTICS RI-20/3B**

Not-operate

Breakdown voltage	min.	400	V
Insulation resistance	min.	10 <sup>3</sup>	MΩ
Capacitance, without test coil	max.	0, 25	pF

		coil I	coil II	coil III	1)
Must-not-operate value	max.	28	16	23	At

Operate

Must-operate value	max.	52	25	40	At
Operate time, including bounce	typ.	0, 5			ms
	max.	1, 0			ms
Bounce time	typ.	0, 4			ms
	max.	0, 7			ms
Contact resistance, initial	typ.	140			mΩ
	max.	300			mΩ

Not-release

Must-not-release value	min.	32	18	26	At
------------------------	------	----	----	----	----

Release

Must-release value	max.	12	8	11	At
Release time	max.	50			μs

1) Coil I : Standard coil.

Coil II : Recommended coil.

see page 6

Coil III: Miniature coil A according to MIL-S-55433B.

2) Measured with 100 At.

3) Measured with 70 At , distance between measuring points: 41 mm.  
Wire resistance typ. 2, 5 mΩ/mm.

**CHARACTERISTICS RI-20/3C**

Not-operate

Breakdown voltage	min.	400	V
Insulation resistance, initial	min.	10 <sup>3</sup>	MΩ
Capacitance, without test coil	max.	0,25	pF

		coil I	coil II	coil III	
Must-not-operate value	max.	46	23	36	At
<u>Operate</u>					
Must-operate value	max.	70	31	53	At
Operate time, including bounce	typ.	0,5 <sup>2)</sup>			ms
	max.	1,0 <sup>2)</sup>			ms
Bounce time	typ.	0,4 <sup>2)</sup>			ms
	max.	0,7 <sup>2)</sup>			ms
Contact resistance, initial	typ.	140 <sup>3)</sup>			mΩ
	max.	300 <sup>3)</sup>			mΩ
<u>Not-release</u>					
Must-not-release value	min.	32	18	26	At
<u>Release</u>					
Must-release value	max.	12	8	11	At
Release time	max.	50 <sup>2)</sup>			μs

Notes: see page 3.

**LIMITING VALUES** (Absolute max. rating system)

Switched power	max.	10	W
Switched voltage , d.c. a.c. (r.m.s.)	max.	150	V
	max.	110	V
Switched current , d.c. or a.c. (r.m.s.)	max.	500	mA
Current through closed contacts, d.c. or a.c. (r.m.s.)	max.	1	A
Temperature, storage and operating	max.	125	°C <sup>1)</sup>
	min.	-55	°C

**LIFE EXPECTANCY AND RELIABILITY**

For life expectancy data end of life is defined as being reached when:  
 either a) the contact resistance once exceeds 1 Ω for no-load conditions or 10 Ω for  
           loaded conditions, measured 5 ms after energizing coil;  
 or    b) the release time once exceeds 5 ms after de-energizing the coil (latching or  
           contact sticking).

No-load conditions (operating frequency 50 Hz).

Life expectancy min. 10<sup>8</sup> operations with a failure rate of less than 10<sup>-8</sup> with a confidence level of 90%.  
 After each operation a) and b) are tested.

Loaded conditions (Resistive load: 12 V, 2 mA, operating frequency 50 Hz).

Life expectancy min. 10<sup>7</sup> operations with a failure rate of less than 10<sup>-8</sup> with a confidence level of 90%.  
 After each operation points a) and b) are tested.

Note

Switching other loads involves different life expectancy and reliability. Consult us beforehand.

**SHOCK AND VIBRATION**

Impact: Acceleration 50 g during 11 ms, due to a force perpendicular to the flat sides of the reeds.  
 Such an impact will not cause an open contact (no magnetic field present) to close, nor a contact kept closed by an 80 At coil to open.

Vibration: Frequency range 50 Hz to 2000 Hz, acceleration 10 g due to a force perpendicular to the flat sides of the reeds.  
 Such a vibration will not cause an open contact (no magnetic field present) to close, nor a contact kept closed by an 80 At coil to open.

<sup>1)</sup> Excursions up to 150 °C may be permissible. Consult us.

**COILS**

Coil I: Standard coil

5000 turns of 42 SWG single enamelled copper wire on a coil former of 25,4 mm winding length and a core diameter of 8,75 mm.

Coil II; Recommended coil

5000 turns of 46 SWG single enamelled copper wire on a coil former of 7,1 mm winding length, a core diameter of 3,7 mm and an outer diameter of 8,3 mm.

Coil III: Miniature coil A according to MIL-S-55433B

10000 turns of 48 SWG single enamelled copper wire on a coil former of 19,05 mm winding length and a core diameter of 4,32 mm.



Dimensions in mm

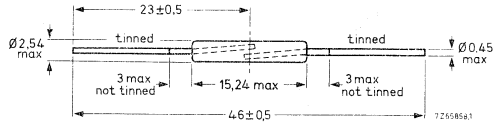
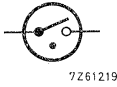

Mechanical strength

The robustness of terminations is tested according to IEC Publication 68-2-21, test Ua (load 1 kg), and Uc ( $3 \times 360^\circ$ ).

For all further data please refer to the RI-20SERIES



## DRY REED CONTACT UNIT

Mini dry reed contact unit hermetically sealed in a gas-filled glass capsule. Single-pole, single-throw type, having normally open contacts, and containing two magnetically actuated reeds. The contact unit is of the double-ended type and may be actuated by means of either an electromagnet or a permanent magnet or combinations of both. The device is intended for use in relays, push buttons or similar devices in conjunction with semiconductor circuits.

### QUICK REFERENCE DATA

Contact	S. P. S. T. normally open		
Switched power	max.	10	W
Switched voltage, d. c. a. c. (r. m. s.)	max.	350	V
	max.	220	V
Switched current	max.	500	mA
Contact resistance, initial	max.	100	mΩ
Basic magnetic characteristics, measured with the Standard coil			
Operate range	30	to	70 At
Release range	9,5	to	21 At

### MECHANICAL DATA

Dimensions in mm

Contact arrangement	normally open
Lead finish	tinned
Resonant frequency of single reed	approx. 2000 Hz
Net mass	approx. 0,3 g
Mounting position	any

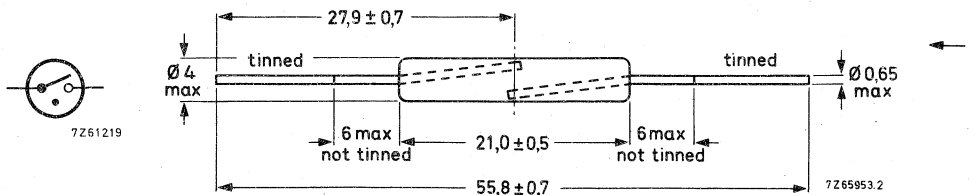

Mechanical strength

The robustness of terminations is tested according to IEC Publication 68-2-21, test Ua (load 3,5 kg), Ub (load 0,5 kg, 2 bends), and Uc (3 x 360°).

Mounting

The leads should not be bent nearer than 2 mm to the glass-to-metal seals. Stress on the seals should be avoided.

Care must be taken to prevent stray magnetic fields from influencing the operating and measuring conditions.

Soldering

The contact unit may be soldered direct into the circuit but heat conducted to the glass-to-metal seals should be kept to a minimum by the use of a thermal shunt.

Dip-soldering is permitted to a minimum of 6 mm from the seals at a solder temperature of 240 °C during maximum 10 s.

Solderability

Solderability is tested according to IEC Publication 68-2-20, test T, solder globule method.

Weldability

The leads are weldable.

**CHARACTERISTICS** See also "General Reed contact units"

Not-operate

Breakdown voltage	min.	750	V <sup>5)</sup>
	min.	1000	V <sup>6)</sup>
Insulation resistance, initial	min.	10 <sup>3</sup>	MΩ
Capacitance, without test coil	max.	1	pF

		coil I	coil II	
Must-not-operate value	max.	30	31	At
<u>Operate</u>				
Must-operate value	max.	70	75	At
Operate time, including bounce	typ.	0,6 <sup>2)</sup>		ms
	max.	1,0 <sup>2)</sup>		ms
Bounce time	typ.	0,3 <sup>2)</sup>		ms
	max.	0,5 <sup>2)</sup>		ms
Contact resistance, initial	typ.	70 <sup>3)</sup>		mΩ
	max.	100 <sup>3)</sup>		mΩ

Notes: see page 4.

Not-release

Must-not-release value	min.	21	22	At
------------------------	------	----	----	----

Release

Must-release value	max.	9,5	9,5	At
--------------------	------	-----	-----	----

Release time	max.	50 <sup>2)</sup>		$\mu$ s
--------------	------	------------------	--	---------

**LIMITING VALUES** (Absolute max. rating system)

Switched power		max.	10	W
----------------	--	------	----	---

Switched voltage , d. c. a. c. (r. m. s.)		max.	350	V
			220	V

Switched current, d. c. or a. c. (r. m. s.)		max.	500	mA
---	--	------	-----	----

Switched current, surge (T = max. 100 ns)		max.	1	A <sup>4)</sup>
---	--	------	---	-----------------

Current through closed contact, d. c. or a. c. (r. m. s.)		max.	1,5	A
---	--	------	-----	---

Temperature, storage and operation		max.	125	$^{\circ}$ C
		min.	-55	$^{\circ}$ C

**LIFE EXPECTANCY AND RELIABILITY**

For life expectancy data end of life is defined as being reached when:

either a) the contact resistance exceeds 1  $\Omega$  for no load conditions or 5  $\Omega$  for loaded conditions, measured 5 ms after energizing coil I to 100 At.

or b) the release time once exceeds 5 ms (latching or contact sticking), after de-energizing coil I to 4 At.

No-load conditions

Operating frequency 50 Hz.

Life expectancy min.  $10^8$  operations with a failure rate of less than  $10^{-8}$  with a confidence level of 90%.

After each operation a) and b) are tested.

Loaded conditions

Resistive load: 12 V, 100 mA, operating frequency 50 Hz.

Life expectancy min.  $10^7$  operations with a failure rate of less than  $10^{-8}$  with a confidence level of 90%.

After each operation a) and b) are tested.

Notes: see page 4.

## SHOCK AND VIBRATION

Mechanical shock is tested according to IEC Publication 68-2-27, test Ea (peak acceleration 500 g, half sine-wave).

Such a mechanical shock will not cause an open contact (no magnetic field present) to close, nor a contact kept closed by an 80 At coil to open.

Vibration is tested according to IEC Publication 68-2-6, test Fe, procedure B4 (acceleration 10 g, below cross-over frequency amplitude 0,75 mm, frequency range 10-500 Hz, duration 90 min.). Such a vibration will not cause an open contact (no magnetic field present) to close, nor a contact kept closed by an 80 At coil to open.

## COILS

### Coil I: Standard coil

5000 turns of 42 SWG single enamelled copper wire on a coil former of 25,4 mm winding length and a core diameter of 8,75 mm.

### Coil II: Intermediate coil C according to MIL-S-55433B

10 000 turns of 41 SWG single enamelled copper wire on a coil former of 25,4 mm winding length and a core diameter of 7,62 mm.

1) Coil I: Standard coil.

Coil II: Intermediate coil C according to MIL-S-55433B.

2) Measured with 100 At.

3) Measured with 32 At, distance between measuring points 41 mm.

4) Surges (e.g. due to stray capacitances of cables) up to 1,5 A are permissible provided these surges decay to values within the limiting values in less than 0,8  $\mu$ s.  
Submicrosecond surges may shorten contact life significantly.

5) Measured after pre-ionization.

6) Measured without pre-ionization.

## DRY REED CONTACT UNIT

Miniature dry reed contact unit hermetically sealed in a glass capsule. Single-pole, single-throw type, having normally open contacts, and containing two magnetically actuated reeds. The contact unit is of the double-ended type and may be actuated by means of either an electromagnet or a permanent magnet or combinations of both. The device is intended for use in telephone exchange relays.

QUICK REFERENCE DATA			
Contact	S. P. S. T. normally open		
Switched power	max.	10	W
Switched voltage	max.	200	V
Switched current	max.	500	mA
Contact resistance (initial)	max.	100	mΩ
Basic magnetic characteristics, measured with the Standard coil			
Operate range	30	to	70 At
Release range	9,5	to	21 At

### MECHANICAL DATA

Dimensions in mm

Contact arrangement	normally open
Lead finish	tinned
Resonant frequency of single reed	approx. 2000 Hz
Net mass	approx. 0,3 g
Mounting position	any

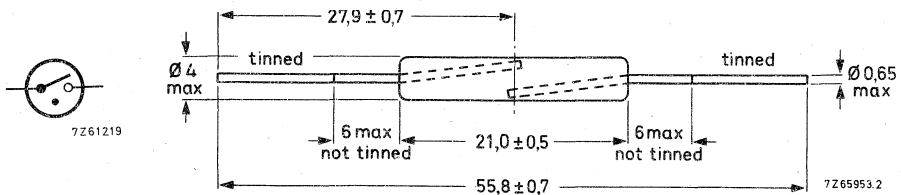

### Mechanical strength

The robustness of terminations is tested according to IEC Publication 68-2-21, test Ua (load 3,5 kg), Ub (load 0,5 kg, 2 bends) and Uc (3 x 360°).

Mounting

The leads should not be bent nearer than 2 mm to the glass-to-metal seals. Stress on the seals should be avoided. Care must be taken to prevent stray magnetic fields from influencing the operating and measuring conditions.

Soldering

The contact unit may be soldered direct into the circuit but heat conducted to the glass-to-metal seals should be kept to a minimum by the use of a thermal shunt. Dip-soldering is permitted to a minimum of 6 mm from the seals at a solder temperature of 240 °C during maximum 10 s.

Solderability

Solderability is tested according to IEC Publication 68-2-20, test T, solder globule method.

Weldability

The leads are weldable.

**CHARACTERISTICS**

Not-operate

Breakdown voltage	min.	750	V <sup>5)</sup>
	min.	1000	V <sup>6)</sup>
Insulation resistance, initial	min.	10 <sup>3</sup>	MΩ

		coil I	coil II	coil III	
Must-not-operate value	max.	30	21	31	At

Operate

Must-operate value	max.	70	37	75	At
Operate time, including bounce	max.		1, 1 <sup>2)</sup>		ms
	typ.		0, 3 <sup>2)</sup>		ms
Bounce time	max.		0, 4 <sup>2)</sup>		ms

Hold

Hold value	min.	32	20, 5	33	At
Contact resistance, initial	max.		100 <sup>3)</sup>		mΩ

Not-release

Must-not-release value	min.	21	13	22	At
------------------------	------	----	----	----	----

Release

Must-release value	max.	9, 5	5	9, 5	At
Release time	max.		0, 1 <sup>2)</sup>		ms

Notes: see page 4.

**LIMITING VALUES** (Absolute max. rating system)

Switched power	max.	10	W
Switched voltage	max.	200	V
Switched current	max.	500	mA <sup>4)</sup>
Current through closed contact	max.	1,5	A
Temperature, storage and operating	max.	125	°C
	min.	-55	°C

**LIFE EXPECTANCY**

For life expectancy data end of life is defined as being reached when within 0,1 x the typical number of operations:

- either a) the contact resistance more than once exceeds 1 Ω for no load conditions and 10 Ω for loaded conditions, measured 5 ms after energizing the coil;  
 or b) the release time more than once exceeds 2 ms after de-energizing the coil (contact sticking).

No load conditions

Typical number of operations: 10<sup>8</sup> Operating frequency 50 Hz.

Loaded conditions

p) Resistance load: 50 V, 100 mA Operating frequency 20 Hz.  
 Minimum number of operations: 2 x 10<sup>6</sup>

q) Resistive load: 50 V, 50 mA connected to the contacts by means of the following cables:

Surge impedance (Ω)	Cable length (m)
45	20; 100
75	20; 100
140	20; 100

Minimum number of operations: 0,5 x 10<sup>6</sup> Operating frequency 20 Hz.

r) Discharge of the following floating cables, previously charged to 50 V:

Surge impedance (Ω)	Cable length (m)
45	1; 10; 100
75	1; 10; 100
140	1; 10; 100

Minimum number of operations: 3 x 10<sup>6</sup> Operating frequency 20 Hz.

General: After each operation points a) and b) are tested.

Note: Switching other loads involves different life expectancy and reliability. Consult us beforehand.

## SHOCK AND VIBRATION

Mechanical shock is tested according to IEC Publication 68-2-27, test Ea (peak acceleration 500 g, half sine-wave).

Such a mechanical shock will not cause an open contact (no magnetic field present) to close, nor a contact kept closed by an 80 At coil II to open.

Vibration is tested according to IEC Publication 68-2-6, test Fc, procedure B4 (acceleration 10 g, below cross-over frequency amplitude 0,75 mm, frequency range 10-500 Hz, duration 90 minutes).

Such a vibration will not cause an open contact by an 80 At coil II to open.

## COILS

Coil I: Standard coil

5000 turns of 42 SWG single enamelled copper wire on a coil former of 25,4 mm winding length and a core diameter of 8,75 mm.

Coil II: Recommended coil

2000 turns of 42 SWG single enamelled copper wire on a coil former of 12,5 mm winding length and a core diameter of 4,2 mm with a return circuit of annealed soft iron ( $80 \text{ A/m} < H_C < 96 \text{ A/m}$ ).

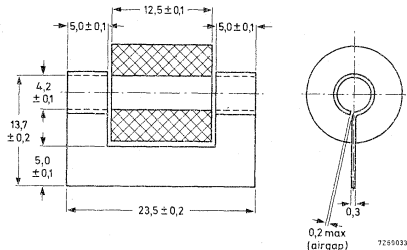
Coil III: Intermediate coil C according to MIL-S55433B

10 000 turns of 41 SWG single enamelled copper wire on a coil former of 25,4 mm winding length and a core diameter of 7,62 mm.

- 1) Coil I : Standard coil.  
Coil II : Recommended coil.  
Coil III: Intermediate coil C according to MIL-S-55433B.
- 2) Measured with 50 At
- 3) Measured with 20 At, distance between measuring points: 38 mm.
- 4) Surges (e.g. due to stray capacitances of cables) up to 1,5 A are permissible provided these surges decay to values within the limiting values in less than 0,8  $\mu$ s. Submicrosecond surges may shorten contact life significantly.
- 5) Measured after pre-ionization.
- 6) Measured without pre-ionization.



## Associated accessories





## 14 PIN TUBE SOCKET

Socket for over-chassis mounting and mounting on a printed-wiring board with reference grid according to IEC publication 97.

The socket is compatible with 14 pin base (e. g. ZM1000).

### MECHANICAL DATA

Dimensions in mm

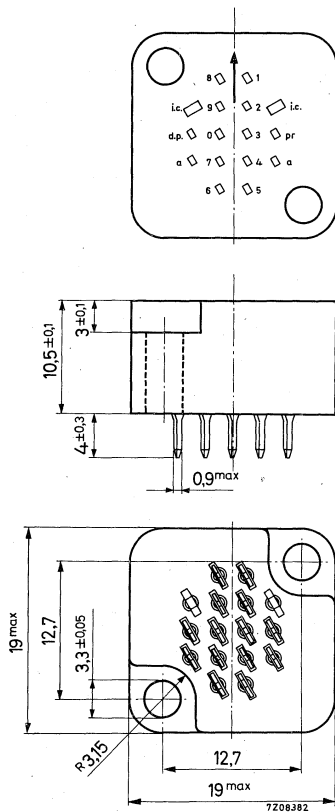

Hole pattern in printed wiring board  
(for bottom view of socket)

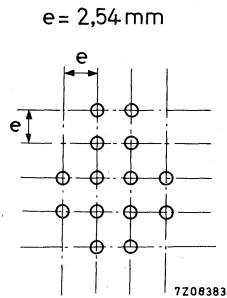

Material: Phenolic  
Contacts: Fork shaped, silver plated



## SNAP-FIT INDICATOR-TUBE ASSEMBLY

A snap-fit indicator-tube assembly consists of a left-hand end piece (1), a number of snap-fit tube holders (2), as many as there are indicator tubes to be fitted side by side, a right-hand end piece (3), and a filter plate (4), which forms the front panel. The filter plate is preferably the blue-light absorbing type made of, for instance, circular-polarized material.

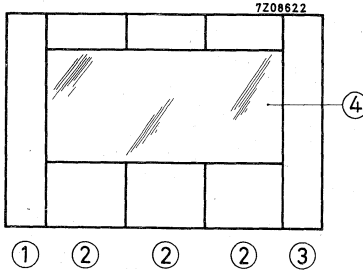

The various items can be fitted easily into a rectangular window cut in the frontplate of a piece of equipment; no tools are needed for mounting and this can take place from the front. A snap-fit indicator-tube assembly can be used with front plates  $1,6 \pm 0,2$  mm thick.

## DIMENSIONS in mm

Material: grey plastic.

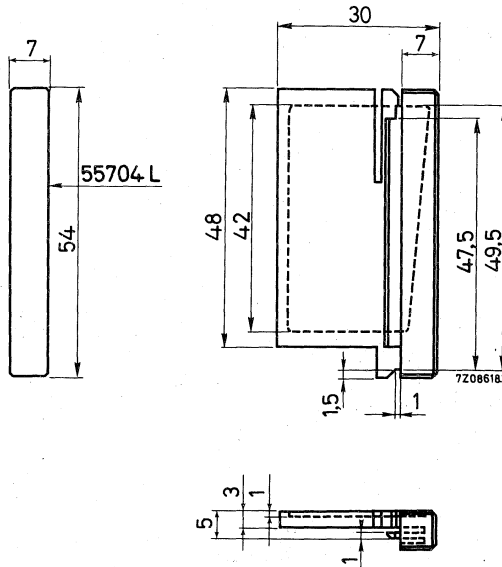
Left-hand end piece

55703

55704

Right-hand end piece

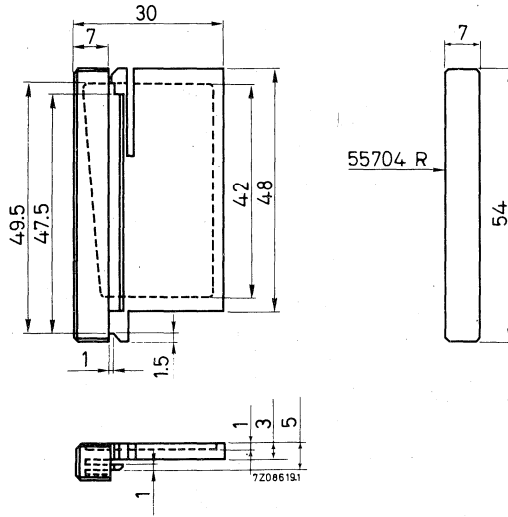

These two items are supplied together under type number 55704  
Snap-fit tube holder Type number 55703

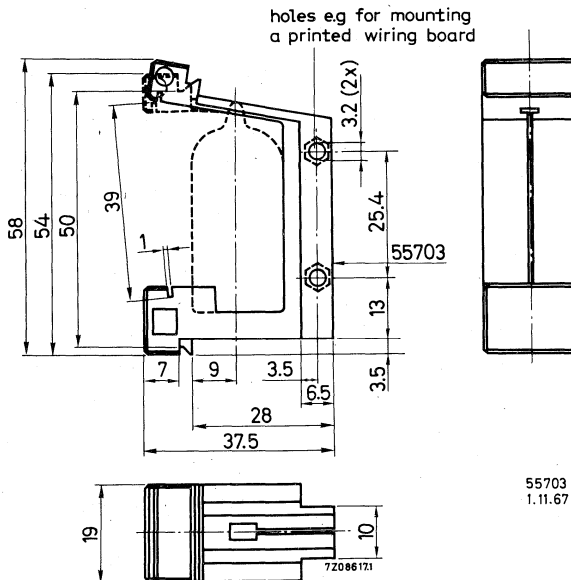

55703  
1.11.67

Window to be cut in the front plate

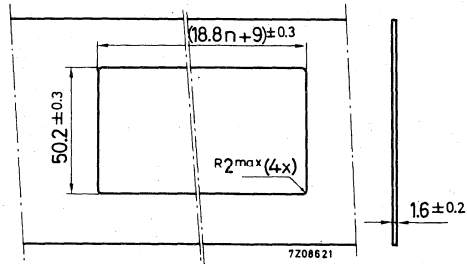

n = number of tube holders type 55703.

plate thickness  $1.6 \pm 0.2$  mm

Filter plate (not included in the delivery)

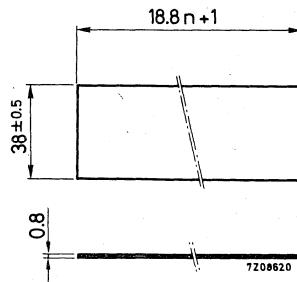

n = number of tube holders 55703

**MOUNTING INSTRUCTIONS**

1. Slide one of the end pieces into position in the window cut in the front plate; Figs. 1a and 1b show this for the left-hand end piece.

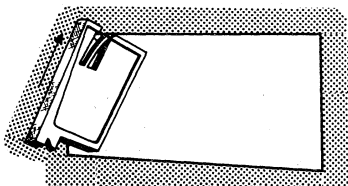

Fig. 1a

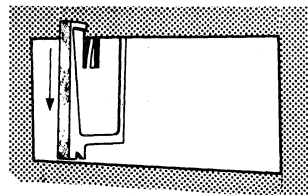

Fig. 1b

2. Slide the snap-fit tube holders into position one by one, see Fig. 2a and 2b.

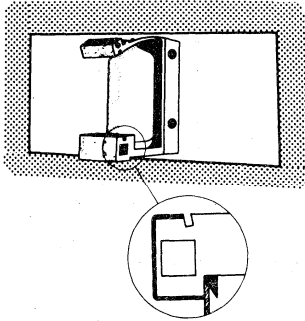

Fig. 2a

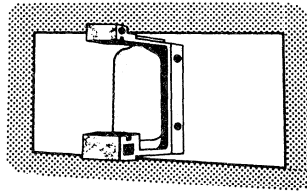

Fig. 2b

3. After the last tube holder has been moved to its place, slide the filter plate into the grooves provided for the purpose, see Fig. 3. Slide the other end piece into position in the manner explained for the first end piece.

Removal of the various items takes place in the reversed order.

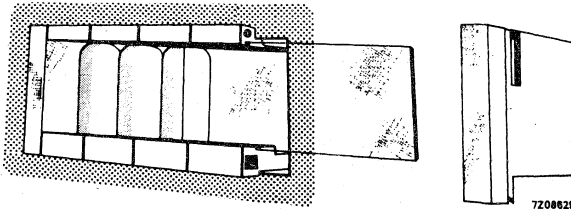

Fig. 3



## 14-PIN TUBE SOCKET

14-pin socket, intended for use with close mounted rectangular envelope indicator tubes.

## MECHANICAL DATA

Dimensions in mm

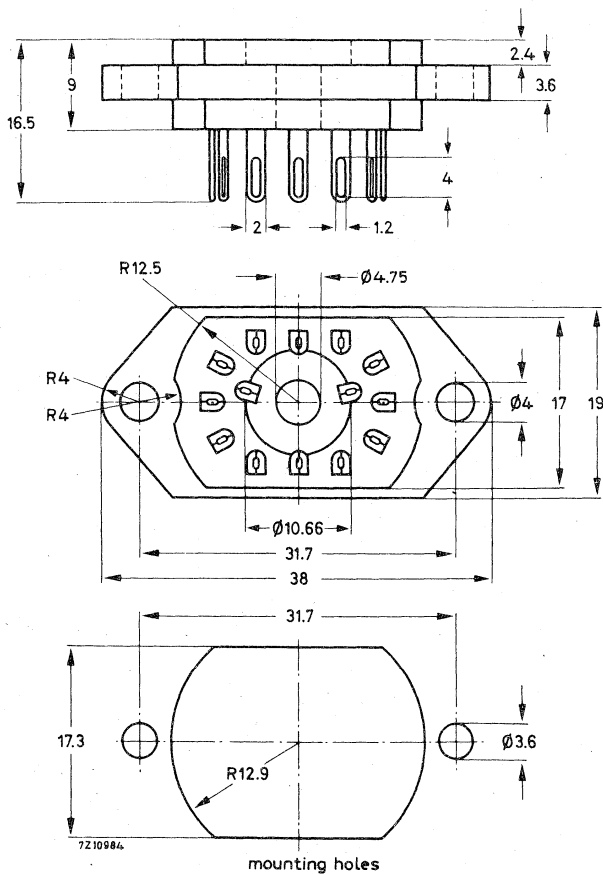



## SOCKET FOR 17-PIN BASE

Socket (laminated) with scraping contacts, compatible with 17-pin base as used with "Pandicon"\* tubes, e.g. ZM1200.

55708 For chassis mounting. Soldering tags with eyelets.

55709 For printed wiring. Soldering tags on circle.

The contacts are silver plated.

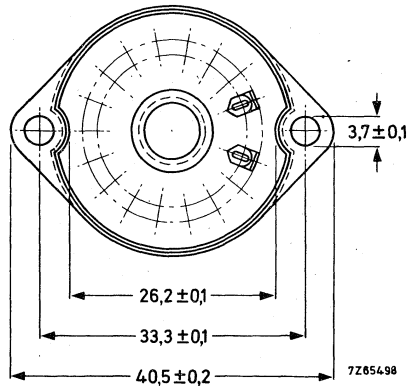
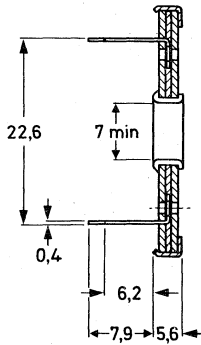
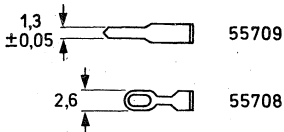

\*Registered Trade Mark for multiple indicator tubes.



## INDEX OF TYPE NUMBERS

Type no.	Section	Type no.	Section
RI-12	D.R.	ZM1020/01	I.T.
RI-20	D.R.	ZM1021	I.T.
RI-21	D.R.	ZM1022	I.T.
RI-42	D.R.	ZM1022p	I.T.
RI-43	D.R.	ZM1023	I.T.
ZA1002	S.D.	ZM1028	I.T.
ZA1004	S.D.	ZM1040	I.T.
ZA1006	S.D.	ZM1041	I.T.
ZM1000	I.T.	ZM1042	I.T.
ZM1001	I.T.	ZM1042/01	I.T.
ZM1002	I.T.	ZM1043	I.T.
ZM1003	I.T.	ZM1043/01	I.T.
ZM1005	I.T.	ZM1550	S.I.T.
ZM1010	I.T.	ZM1551	S.I.T.
ZM1011	I.T.	55702	Acc.
ZM1012	I.T.	55703	Acc.
ZM1013	I.T.	55704	Acc.
ZM1014	I.T.	55705	Acc.
ZM1015	I.T.	55708	Acc.
ZM1020	I.T.	55709	Acc.

D.R. = Dry reed contact units  
 S.D. = Switching diodes  
 I.T. = Indicator tubes  
 S.I.T. = Segment indicator tubes  
 Acc. = Accessories



---

Segment indicator tubes

---

Indicator tubes

---

Switching diodes

---

Dry reed contact units

---

Associated accessories

---

Index

---



**Argentina:** FAPESA I.y.C., Av. Crovara 2550, Tablada, Prov. de BUENOS AIRES, Tel. 652-7438/7478.

**Australia:** PHILIPS INDUSTRIES HOLDINGS LTD., Elcoma Division, 67 Mars Road, LANE COVE, 2066, N.S.W., Tel. 42 1261.

**Austria:** ÖSTERREICHISCHE PHILIPS BAUELEMENTE Industrie G.m.b.H., Triester Str. 64, A-1101 WIEN, Tel. 62 91 11.

**Belgium:** M.B.L.E., 80, rue des Deux Gares, B-1070 BRUXELLES, Tel 523 00 00.

**Brazil:** IBRAPE, Caixa Postal 7383, Av. Paulista 2073-S/Loja, SAO PAULO, SP, Tel. 287-7144.

**Canada:** PHILIPS ELECTRONICS LTD., Electron Devices Div., 601 Milner Ave., SCARBOROUGH, Ontario, M1B 1M8, Tel. 292-5161.

**Chile:** PHILIPS CHILENA S.A., Av. Santa María 0760, SANTIAGO, Tel. 39-40 01.

**Colombia:** SADAPE S.A., P.O. Box 9805 Calle 13, No. 51 + 39, BOGOTA D.E. 1., Tel. 600 600.

**Denmark:** MINIWATT A/S, Emdrupvej 115A, DK-2400 KØBENHAVN NV., Tel. (01) 69 16 22.

**Finland:** OY PHILIPS AB, Elcoma Division, Kaivokatu 8, SF-00100 HELSINKI 10, Tel. 1 72 71.

**France:** R.T.C. LA RADIODIETECHNIQUE-COMPELEC, 130 Avenue Ledru Rollin, F-75540 PARIS 11, Tel. 355-44-99.

**Germany:** VALVO, UB Bauelemente der Philips G.m.b.H., Valvo Haus, Burchardstrasse 19, D-2 HAMBURG 1, Tel. (040) 3296-1.

**Greece:** PHILIPS S.A. HELLENIQUE, Elcoma Division, 52, Av. Syngrou, ATHENS, Tel. 915 311.

**Hong Kong:** PHILIPS HONG KONG LTD., Comp. Dept., Philips Ind. Bldg., Kung Yip St., K.C.T.L. 289, KWAI SHUNG, N.T. Tel. 12-24 51 21.

**India:** PHILIPS INDIA LTD., Elcoma Div., Band Box House, 254-D, Dr. Annie Besant Rd., Prabhadevi, BOMBAY-25-DD, Tel. 457 311-5.

**Indonesia:** P.T. PHILIPS-RALIN ELECTRONICS, Elcoma Division, 'Timah' Building, Jl. Jen. Gatot Subroto, JAKARTA, Tel. 44 163.

**Ireland:** PHILIPS ELECTRICAL (IRELAND) LTD., Newstead, Clonskeagh, DUBLIN 14, Tel. 69 33 55.

**Italy:** PHILIPS S.P.A., Sezione Elcoma, Piazza IV Novembre 3, I-20124 MILANO, Tel. 2-6994.

**Japan:** NIHON PHILIPS CORP., Shuwa Shinagawa Bldg., 26-33 Takanawa 3-chome, Minato-ku, TOKYO (108), Tel. 448-5611.  
(IC Products) SIGNETICS JAPAN, LTD., TOKYO, Tel. (03) 230-1521.

**Korea:** PHILIPS ELECTRONICS (KOREA) LTD., Philips House, 260-199 Itaewon-dong, Yongsan-ku, C.P.O. Box 3680, SEOUL, Tel. 44-4202.

**Mexico:** ELECTRONICA S.A. de C.V., Varsovia No. 36, MEXICO 6, D.F., Tel. 5-33-11-80.

**Netherlands:** PHILIPS NEDERLAND B.V., Afd. Elcoma, Boschdijk 525, NL-4510 EINDHOVEN, Tel. (040) 79 33 33.

**New Zealand:** Philips Electrical Ind. Ltd., Elcoma Division, 70-72 Kingsford Smith Street, WELLINGTON, Tel. 873 156.

**Norway:** ELECTRONICA A/S., Vitaminveien 11, P.O. Box 29, Grefsen, OSLO 4, Tel. (02) 15 05 90.

**Peru:** CADESA, Jr. Ilo, No. 216, Apartado 10132, LIMA, Tel. 27 73 17.

**Philippines:** ELDAC, Philips Industrial Dev. Inc., 2246 Pasong Tamo, MAKATI-RIZAL, Tel. 86-89-51 to 59.

**Portugal:** PHILIPS PORTUGESA S.A.R.L., Av. Eng. Duharte Pacheco 6, LISBOA 1, Tel. 68 31 21.

**Singapore:** PHILIPS SINGAPORE PTE LTD., Elcoma Div., POB 340, Toa Payoh CPO, Lorong 1, Toa Payoh, SINGAPORE 12, Tel. 53 88 11.

**South Africa:** EDAC (Pty.) Ltd., South Park Lane, New Doornfontein, JOHANNESBURG 2001, Tel. 24/6701.

**Spain:** COPRESA S.A., Balmes 22, BARCELONA 7, Tel. 301 63 12.

**Sweden:** A.B. ELCOMA, Lidingövägen 50, S-10 250 STOCKHOLM 27, Tel. 08/ 67 97 80.

**Switzerland:** PHILIPS A.G., Elcoma Dept., Edenstrasse 20, CH-8027 ZÜRICH, Tel. 01/44 22 11.

**Taiwan:** PHILIPS TAIWAN LTD., 3rd Fl., San Min Building, 57-1, Chung Shan N. Rd, Section 2, P.O. Box 22978, TAIPEI, Tel. 5513101-5.

**Turkey:** TÜRK PHILIPS TICARET A.S., EMET Department, Gümüşsuyu Cad. 78-80, Beyoğlu, ISTANBUL, Tel. 45 32 50.

**United Kingdom:** MULLARD LTD., Mullard House, Torrington Place, LONDON WC1E 7HD, Tel. 01-580 6633.

**United States:** (Active devices & Materials) AMPEREX SALES CORP., 230, Duffy Avenue, HICKSVILLE, N.Y. 11802, Tel. (516) 931-6200.  
(Passive devices) MEPCO/ELECTRA INC., Columbia Rd., MORRISTOWN, N.J. 07960, Tel. (201) 539-2000.  
(IC Products) SIGNETICS CORPORATION, 811 East Arques Avenue, SUNNYVALE, California 94086, Tel. (408) 739-7700.

**Uruguay:** LUZIVELTRON S.A., Rondeau 1567, piso 5, MONTEVIDEO, Tel. 9 43 21.

**Venezuela:** IND. VENEZOLANAS PHILIPS S.A., Elcoma Dept., A. Ppal de los Ruices, Edif. Centro Colgate, Apdo 1167, CARACAS, Tel. 36 05 11